

KENWOOD

PORTABLE COMPACT DISC PLAYER

DPC-42

INSTRUCTION MANUAL

KENWOOD CORPORATION



Keep this manual handy for future reference.

For your records

Record the serial number, found on the bottom of the unit, in the spaces designated on the warranty card, and in the space provided below. Refer to the model and serial numbers whenever you call upon your dealer for information or service on this product.

Model DPC-42 Serial number _____

Unpacking

Unpack the unit carefully and make sure that all accessories and cables are put aside so they will not be lost.

Examine the unit for any possibility of shipping damage. If your unit is damaged or fails to operate, notify your dealer immediately. If your unit was shipped to you directly, notify the shipping company without delay. Only the consignee (the person or company receiving the unit) can file a claim against the carrier for shipping damage.

We recommend that you retain the original carton and packing materials for use should you transport or ship the unit in the future.

CAUTION: Use of controls or adjustments or performance of procedures other than those specified herein may result in hazardous radiation exposure.

In compliance with Federal Regulations, following are reproductions of labels on, or inside the product relating to laser product safety.

Location: Bottom panel

CAUTION AGAINST HIGH TEMPERATURE DO NOT LEAVE THIS CD PLAYER IN A PLACE SUBJECT TO HIGH TEMPERATURE, SUCH AS IN DIRECT SUNLIGHT, IN A CAR WITH THE WINDOWS CLOSED OR NEAR A HEATER. (EXCESSIVELY HIGH TEMPERATURE MAY CAUSE A CHANGE OF SHAPE, COLOR OR MALFUNCTION.)	ATTENTION A LA HAUTE TEMPERATURE NE PAS LAISSER CE LECTEUR-CD DANS UN ENDROIT SUJET A HAUTE TEMPERATURE, COMME SOUS LES RAYONS DIRECTS DU SOLEIL, DANS UNE VOITURE AUX FENETRES FERMEES, OU PRES D'UNE SOURCE DE CHALEUR. HAUTE TEMPERATURE EXTREMEMENT PEUT DEFORMER, DECOLORER L'APPAREIL, OU EN CAUSER DES FONCTIONNEMENTS DEFECTUEUX.)
CAUTION FOR APPLICATION NEVER USE EITHER ANY AC OR CAR BATTERY ADAPTOR OTHER THAN AS SPECIFIED.	PRECAUTION NE PAS UTILISER LES ADAPTEURS DE COURANT ALTERNATIF, OU LES ADAPTEURS DE BATTERIE D'AUTOMOBILE, QUI NE SOIENT DE NOTRE DESIGNATION.
CERTIFIED ONLY TO CANADIAN ELECTRICAL CODE CERTIFIE EN VERTU DU CODE CANADIEN DE L'ELECTRICITE SEULEMENT	MANUFACTURED SEPTEMBER 1990 SERIAL NO. KC [REDACTED]
KENWOOD PORTABLE COMPACT DISC PLAYER DPC-42	KENWOOD CORPORATION 2-17-5 SIBUYA, SIBUYA-KU TOKYO 160, JAPAN MADE IN JAPAN
DC 7.5V (EXCLUSIVE AC ADAPTOR) + DC 6V (RB, AA, AM30X4)	KENWOOD CERTIFIES THAT THIS EQUIPMENT CONFORMS TO DHHS REGULATIONS 21 CFR CHAPTER I SUBCHAPTER J.

Location: Inside, surface of disc lid.

	CAUTION: INVISIBLE LASER RADIATION WHEN OPEN AND INTERLOCKS DEFEATED. AVOID EXPOSURE TO BEAM. ATTENTION: RAYON LASER A L'OUVERTURE ET A L'INHIBITION DU VERROUILLAGE. EVITER TOUTE EXPOSITION AU FAISCEAU. VORSICHT: UNSICHTBARE LASERSTRAHLUNG TRITT AUS WENN DECKEL GEÖFFNET UND WENN SICHERHEITSVERRIEGELUNG ÜBERBRÜCKT IST. NICHT DEM STRAHL AUSSETZEN.
--	--

Before applying power of AC adaptor

Important!

USA, Canada, U.K., Europe and Australia

Unit shipped to the above are not equipped with an AC voltage selector switch and the discussion of such a switch that follows should be disregarded.

All other countries

AC adaptor shipped to countries other than the above are equipped with an AC voltage selector switch on the bottom cover. Refer to the following paragraph for the proper setting of this switch.

AC voltage selection

AC adaptor operates on 110~120 volts or 220~240 volts AC. Before connecting the power cord to your AC outlet, make sure that the setting position of this switch matches your line voltage. If not, it must be set to your voltage in accordance with the following direction.

Note:

Our warranty does not cover damage caused by excessive line voltage due to improper setting of the AC voltage selector switch.

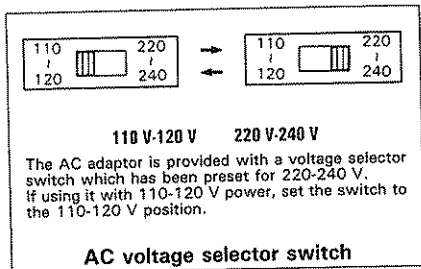
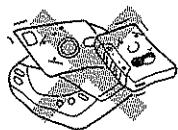

Fig. 1

WARNING:

TO PREVENT FIRE OR ELECTRIC SHOCK, DO NOT EXPOSE THIS APPLIANCE TO RAIN OR MOISTURE.

Precautions for use



- This unit uses a magnet. Do not place a floppy disk, cassette tape, etc. on the unit.

To maintain the high performance and reliability of this unit, avoid using or storing it in the following conditions.



- Dusty places.

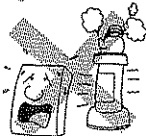

- Near heat sources such as stoves, etc.

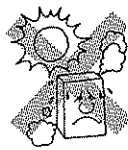

- Places exposed to direct sunlight, especially in a closed car.



- Extremely cold places.

For United Kingdom

The mains plug must be removed from the wall socket prior to any internal examination.

Important

The wires in this mains lead are coloured in accordance with the following code:

Blue Neutral
Brown Live

The wires in this mains lead must be connected to the terminals in the plug as follows:

Wire colour Plug terminal marking

Blue N or Black
Brown L or Red

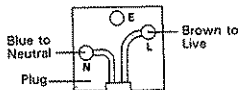

Notes:

- 1) If a 13-amp plug is used, this must be fitted with a 5-amp fuse.
- 2) If a 3-pin plug with earthing contact is used, no wire must be connected to the E terminal.

WARNING NOTICE:

IN MOST CASES IT IS AN INFRINGEMENT OF COPYRIGHT TO MAKE COPIES OF TAPES OR DISCS WITHOUT THE PERMISSION OF THE COPYRIGHT OWNERS. ANYONE WISHING TO COPY COMMERCIALY AVAILABLE TAPES OR DISCS SHOULD CONTACT THE MECHANICAL COPYRIGHT PROTECTION SOCIETY LIMITED OR THE PERFORMING RIGHTS SOCIETY LIMITED.

■ Condensation (dew)

- When the unit is placed in a humid place or just after heater is turned on, condensation may form inside the unit and unit may not function correctly. At that time, press the [■] (STOP) button twice to turn off the unit (when the button is pressed once, the unit only enters stop mode), leave the unit for about 1 hour, then load a disc and start play.

■ Using headphones

- CD players have such a low noise level that listeners often tend to overly increase the sound volume. Set the sound volume to an appropriate level to protect your ears from excessive shock.
- For your safety and the safety of others, do not use headphones while driving a car or other type of vehicle.
- Be careful not to fall asleep while listening to music using headphones.
- Continuous use of headphones for long periods may hurt your ears.

Fig. 1

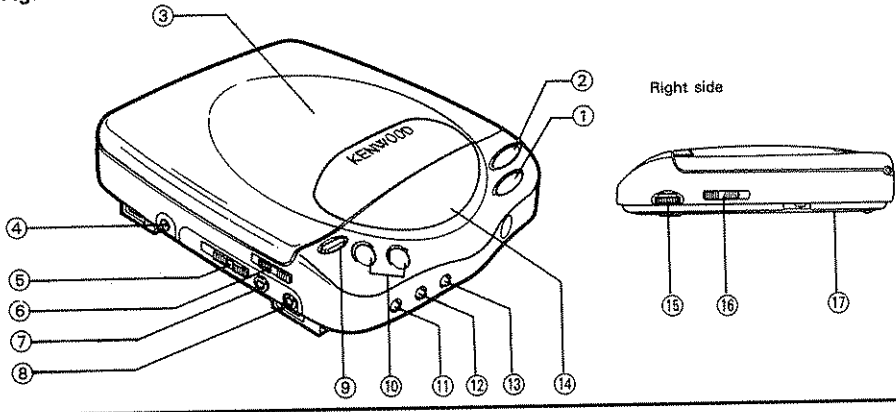

Fig. 2

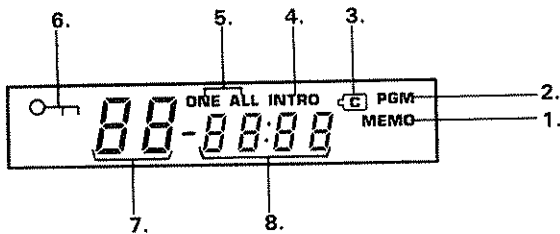
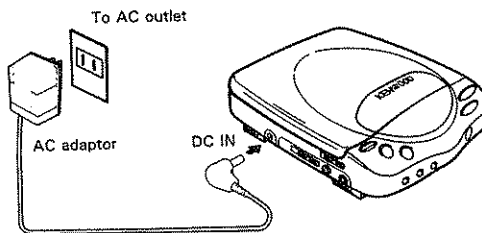

Fig. 3



Controls, connectors and indicators <Fig. 1>

- ① PLAY/PAUSE [▶||] button (POWER ON)
- ② [■] STOP/OFF button (POWER OFF)
- ③ Lid
- ④ DC IN jack
- ⑤ SP switch
- ⑥ Lid Lock knob
- ⑦ LINE OUT jack
- ⑧ PHONES jack
- ⑨ OPEN button
- ⑩ [◀▶] SKIP/SEARCH button
- ⑪ REPEAT button
- ⑫ P.MODE (Program mode) button
- ⑬ CHARGE button
- ⑭ Display
- ⑮ VOLUME control knob
- ⑯ HOLD/LAST MEMO. (Last track memory) switch
- ⑰ Battery cover

Display description <Fig. 2>

1. MEMO (Last track memory) indicator.
2. PGM (Program mode) indicator
3. CHARGE indicator
4. INTRO (Introduction play) indicator
5. Repeat mode indicator
6. HOLD indicator
7. Track number display
8. Elapsed time display

Power source

■ Use in the following method:

Household AC Power Source	Use the provided AC adaptor.
Alkaline dry Battery	Use size AA alkaline dry batteries which are available in the general market.
Rechargeable Battery (Provided)	Charge with the provided AC adaptor before use.
Car Battery	Use the optional car-battery adaptor DC-C6 (exclusive for 12-V car).

■ How to use the main unit with the provided AC adaptor <Fig. 3>

- When this provided AC adaptor is used, the power source can be supplied from household outlets. Insert the plug of the AC adaptor into the power-source terminal, then connect the AC power adaptor to a household outlet.
- Pull out the AC adaptor from the outlet when it is not in use. Conduct insertion into or pulling out from the power source terminal after pressing the STOP [■] button twice in order to turn the main unit into "POWER OFF" condition.

■ How to use the unit with the provided rechargeable batteries or alkaline dry batteries

The usable batteries are only the provided rechargeable batteries.
Generally marketed rechargeable batteries and manganese dry batteries cannot be used.

● **How to Insert the batteries into the battery compartment < Fig. 4 >**

① **Open the battery cover.**

② **Insert the batteries.**

Insert the four provided rechargeable batteries or alkaline dry batteries into the battery compartment surely by paying attention for correct polarity.

③ **Close the battery cover.**

Fit the hook of battery cover into the specified position.

Be sure to fit it into the specified position until it clicks and gets locked.

Charge the provided rechargeable batteries for 6 hours, if you use them for the first time.

Fig. 4

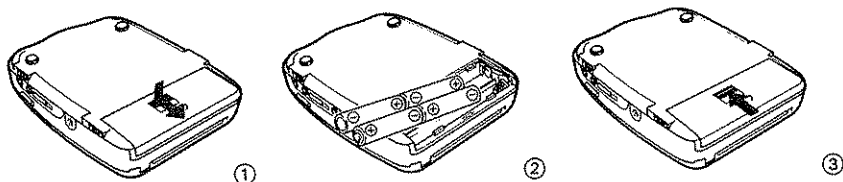

● **How to Recharge < Fig. 5 >**

Turn the Power off and insert provided rechargeable batteries into the battery compartment, then connect an AC adapter to the main unit before pressing CHARGE button in order to start recharging. (Recharging cannot be conducted when Power is turned ON)

During recharging, the  mark blinks slowly.

Recharging is canceled automatically by the built-in and 6-hour timer when recharging is completed.

1. Recharging will be canceled when PLAY/PAUSE [▶ ||] button is pressed during recharging. Other operations cannot be conducted.
2. The CHARGE button functions even though when the HOLD switch is turned ON.
3. Recharging is canceled when the AC-adapter plug is pulled out an outlet while recharging is being conducted, or when power supply is cut.

Fig. 5

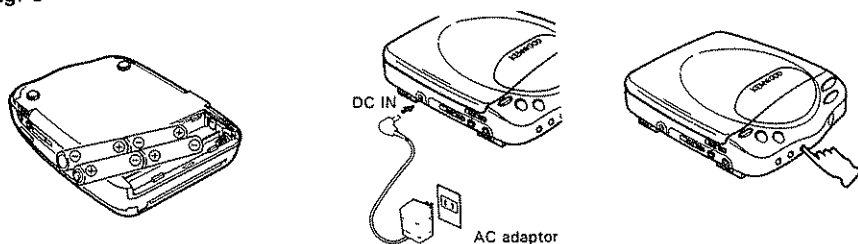

● How to Recognize the Recharging Time

In the normal use, 5 hours of recharging allows continuous play for about 2 hours.

Recharge them for about 6 hours, however, if they are not used for a long period of time.

● How to make batteries stand up to long use

If recharge is repeated for the provided batteries, where as the power of batteries is still remained, the batteries may not be recharged enough as their property. In such a case, use up the power of them before conducting recharging, which allows them for normal recharging.

● Service Life of Rechargeable Battery

Rechargeable battery has a life.

After about 500 times of recharging, its performance (operating time) is halved as compared to a new battery. If operating time shortens considerably although you have charged your battery properly, four rechargeable batteries for replacement.

Cautions:

- Do not recharge the manganese or alkaline dry battery.
- Be sure to use only the provided AC adaptor for recharging. It is dangerous if you use other kind of AC adaptor.
- Avoid adverse recharging or short circuit. They result in causing of such troubles as deterioration of rechargeable batteries and generation of heat.
- Do not disassemble or modify it by yourself.
- Do not touch the CD player or AC adaptor with wet hands.

Listening through headphones < Fig. 6 >

- Connect the headphone plug with the "PHONES" jack. Conduct the pull-in/out operation of the jack during Power is OFF.
- Adjust the volume with the VOLUME control.

Notes:

- Keep the plug of headphone clean all the time. Non-clean plug may cause noise.
- Avoid using the headphone when you drive a car and so on for traffic safety.
- Be careful not to fall asleep with the headphone on.

Fig. 6

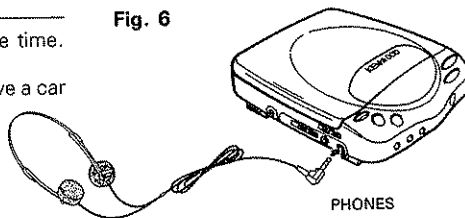

As a Compact Disc contains very little noise, a sudden loud sound could be output if the VOLUME control is adjusted too high: this could cause serious damage to your ears.

Note on SP switch

When the SP switch is set ON, a circuit is activated to boost the low frequencies as well as to reduce unnatural feeling when listening through headphones.

Playback through a home audio system

■ Playback using the "LINE OUT" output <Fig. 7>

- Using the provided audio connection cord, connect the 3-pin miniplug to "LINE OUT" terminal of this unit.
Connect the other end of the cord to the amplifier's external input jacks (AUX jacks, TAPE PLAY jacks, etc.).
Connect the red plug to the "R" (right channel) input jack and the white plug to the "L" (left channel) input jack.
- Adjust the sound volume using the amplifiers volume control.
- When the direct input from the main unit to a tape deck is to be made, adjust the volume with volume-level adjuster (REC LEVEL) of the tape deck.

Caution:

- Before making connections, be sure to turn the amplifier power off.

Do not connect the main unit to the PHONO terminal of the amplifier.

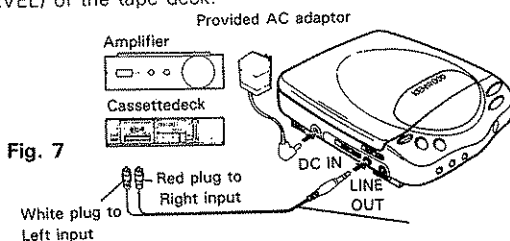

CD playback in an automobile <Fig. 8>

■ Use in the car audio cassette adaptor CAC-1 (optional)

- When the power source is taken from a cigar socket of a car, use the car battery adaptor DC-C6. It allows you to enjoy listening to music for a long time without worrying about the battery consumption.
- Insert the plug of car audio cassette adaptor CAC-1 into the "LINE OUT" terminal of the main unit. Insert the CAC-1 to the car component deck, and turn the car component deck into the PLAY mode.
- Adjust the sound volume using the volume control of the car stereo.

Notes:

- **Since car battery adaptors available in the market have different polarity and voltage, they may result in troubles.**
(Be sure not to use a car battery adaptor other than the optional DC-C6.)
- In case the unit is used in a car, install it taking the safety in consideration, so that it does not interfere with the driving operations.
- The CAC-1 cannot be used with some car audio cassette models.
- Do not leave the unit in a closed automobile where the temperature is expected to be high.
- Place the unit on a soft place where automobile vibrations are not easily transmitted.
- If any sound skipping occurs due to vibrations, turn on the [HOLD] switch to reduce the sound skipping.

Fig. 8

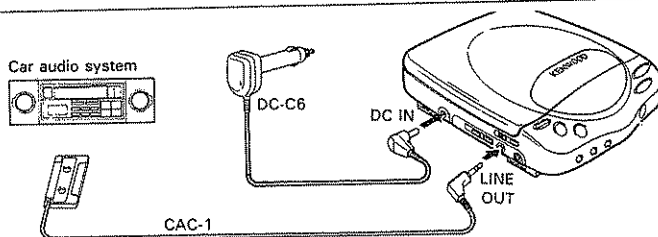

8 cm CD single can also be played

This unit can play 8 cm CD singles directly without using an adaptor.

Caution:

- Do not use an adaptor sold for other models (otherwise the CD or this unit may be damaged).

How to play (Manual play)

Manual Play (Basic Operation)

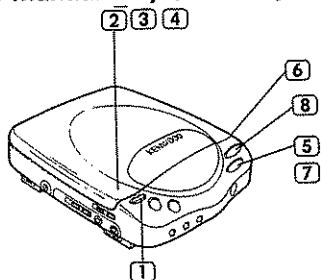

Leave the HOLD/LAST MEMO switch turned OFF.

- Push the OPEN button.
- Open the lid: Lightly lift the lid near the OPEN button.
- Insert the disk: Be sure to keep the label side of the disk upward.
- Close the lid.
- Push the PLAY/PAUSE [▶ II] button: The unit starts playing automatically after scanning the data of the disk.
- Adjust the volume.

When PLAY/PAUSE [▶ II] button is pressed to POWER ON.

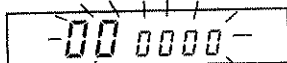

Blink

When the unit starts playing automatically.

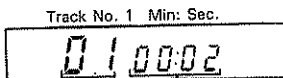

Track being played

Elapsed playing time

In the event that data is not read or a disc is not inserted. (It will turn out to be POWER OFF after elapsing of three minutes.)

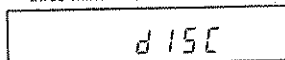

PLAY MODE

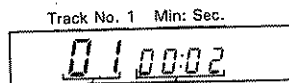

Track being played

Playback time blinks here.

STOP MODE

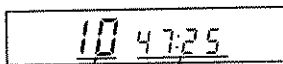

Total number of tracks

Total playing time

To operate temporary stop (pause)

- Push PLAY/PAUSE [▶ II] button: If you press it once more, the unit starts playing from the paused position.

To stop

- Push the STOP [■] button:
 - If the STOP [■] button is pressed once, the unit is put in the stop mode. If it is pressed once again, the unit is turned out to be POWER OFF.
 - If the stop mode lasts for 3 minutes or more, the unit is turned out to be POWER OFF.

Notes:

- If the HOLD switch is being turned ON, PLAY/PAUSE [▶ ||] operation cannot be activated even the button is pressed.
- If OPEN button is pressed, all the contents is erased and the unit is turned out to be POWER OFF.
- If the lid is open, all the functions do not work. Closing the lid does not simply allow the unit to turn out to be POWER ON.
- If the PLAY/PAUSE [▶ ||] button is pressed during the stop mode, the unit starts playing from the first track.
- When the music is played until the final track and the player has naturally entered the stop Mode, it indicates the total playing time.
- Be sure not insert the disk up side down. If the disk is inserted into the unit with reverse side up, the unit can not start playing.
- Do not insert anything other than the disk into the disk tray.
- A disk may be damaged if it is inserted diagonally into the disk tray.

■ **To skip to the beginning of desired track (Skip feature, ◀◀, ▶▶), to search in the forward or backward direction (Search feature, ◀◀, ▶▶)**

- The skip function is activated with one press of button and the search function is activated with continuous press of button.
- Operate during play (Basic Operations (5), (6)), or stop mode (Basic Operation (8)).

⑨ **To skip to the beginning of the track being played:**

Tap the ◀◀ button for an instant.

To skip to the beginning of the next track:

Tap the ▶▶ button for an instant.

- When you wish to skip back to the previous track, press the ◀◀ button once more.
- The first music is caused to play if ▶▶ button is pressed while the last music is being played.
- If you press ◀◀ button during the stop mode, the last track is activated to play.

⑩ **How to operate the quick return with the main unit:**

Push ◀◀ button continuously.

How to operate the quick traverse:

Push ▶▶ button continuously.

- If you release the quick return and quick traverse buttons, the unit plays the music from that position.
- If an operation is made during the pause mode, the music is paused at the position where the button is released.

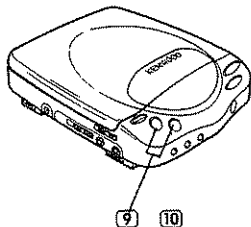

How to play (Repeat play)

■ Repeat play

- If the REPEAT button on the main unit is pressed during play or stop mode (basic-operation [8]), repeat play will be activated.

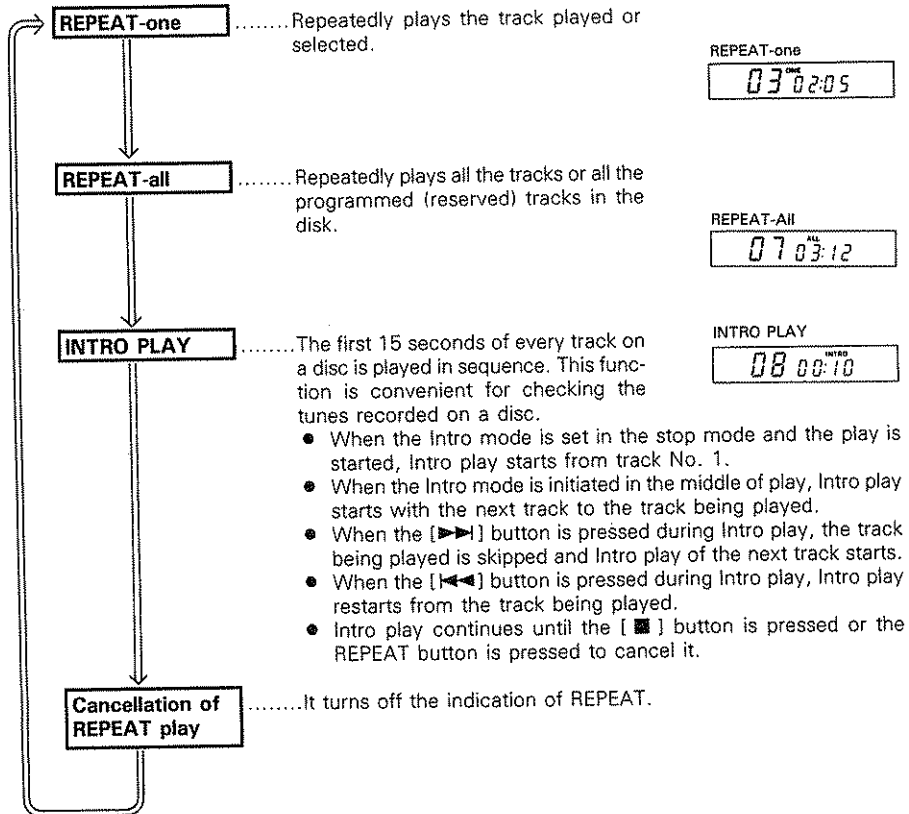
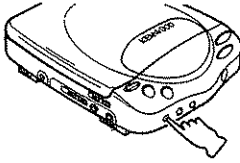

How to Stop play

Press the STOP [■] button on the main unit.

How to Play (Program Play)

- Operate during the stop mode (Basic operation (6)). It cannot be operated if the mode is in other than the stop mode.
- 16 tracks can be programmed (reserved) in the order you like to listen to.
- After completion of the programming (reservation), play is activated if "PLAY/PAUSE [▶||]" is pressed.

■ How to program with the FF/REV [◀◀ ▶▶] button

(11) Push P. MODE button:

- Enters the program input mode.

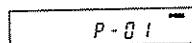

(12) Select with the FF/REV [◀◀ ▶▶] button (Program number 1):

- The same operation as in (9) and (10).

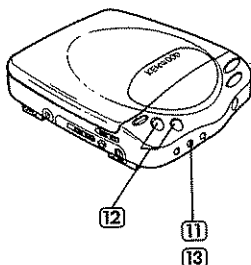
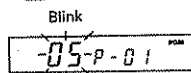

(13) Push the P. MODE button.

(It means that the music has been set as the firstly played track)

(14) Select the track (from Program 2, 3, ... 16):

- Repeat the operation in (12) and (13).
- The maximum number of input tracks for program is 16. The following indication is shown after those 16 tracks are input.

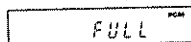
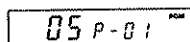

- During the programmed play, the unit is in the auto space mode. Then, the four-second pause is inserted between the tracks.
- If the skip [◀◀ ▶▶] button is pressed during the programmed play, skip search can be made only with the programmed track.
- When the program is called during the program stand-by mode and the PLAY/PAUSE [▶||] button is pressed with HOLD/LAST MEMO. OFF (See Page 13), the player will play from the first track programmed, not the track whose number is indicated now.

■ Confirmation of the programmed contents

- This function can be operated when the disc is programmed and stopped.

(15) Push the P.MODE button:

- Indicates the program number 1.

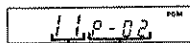

Track programmed Program No.

(16) If the P. MODE button is pressed repeatedly:

- Then the programmed contents are indicated in order.
- If the music orders are indicated until the last programmed track, the indication returns to Program number 1.

■ How to cancel all the programs

⑰ Put the unit to POWER OFF or open the lid:

- Push the STOP [■] button once when the music is programmed and the disc is stopped in order to enter the unit into the stop mode, or press the STOP [■] button twice during play in order to put the unit to POWER OFF.
- Push the open button.

■ How to change the contents of the program

⑱ Call the program number to be changed by pressing the P. MODE button:

Example:

When you wish to change the music in Track 11 of the Program Number 2 to Track 8, call the Program Number 2 by pressing the P. MODE button.

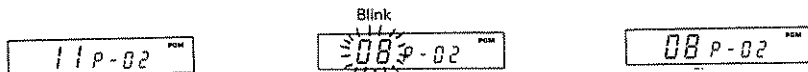

- You can also revise the track after indicating the Track 8 with ◀◀ and ▶▶ buttons on the main unit, and then pressing the P. MODE button.

Convenient functions

■ Prevention of misoperation [HOLD]/Reduction of sound skip [Anti shock]/Last memory function

- This unit has the HOLD function to prevent misoperation, the anti-shock function to reduce the sound skipping and the LAST MEMO. function to memorize the music until the power is turned off. When the unit is used in the car or elsewhere where there is big vibrations, the sound skipping is reduced.

Turn on the HOLD switch:

- If the "HOLD" is turned on in the POWER OFF mode, the unit will not be turned to the POWER ON mode even though the PLAY/PAUSE [▶||] button is pressed.
- If the "HOLD" is turned on during the play, the button switches other than the "OPEN" button can not be operated.

When the LAST MEMO. switch is turned on, the following operations are made:

- When the power is turned on from the off condition, the player starts to play the music from the beginning part of the track where the present location of the pick-up is read.
- If the STOP [■] button is pressed and the PLAY/PAUSE [▶||] button is pressed again, the player starts to play from the beginning part of the stopped track. (When it is paused at the near end of a track, it may start playing from the beginning part of the following track.)
- If the SKIP button [◀◀] is pressed during the stop mode, the player starts to play the track previous to the track for which the STOP [■] button is pressed.
- If the SKIP button [▶▶] is pressed during the stop mode, the player starts to play the track next to the track for which the STOP [■] button is pressed.
- The Last track memory function also work even in the Hold ON status.

HOLD indicator

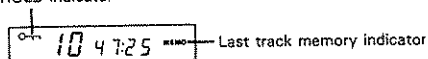

Simple care and maintenance

■ Cleaning the cabinet

When the cabinet gets dirty, wipe it with a dry cloth. If the stain is so serious that it cannot be removed with a dry cloth, moisten the cloth with a small amount of water. After wiping with the moistened cloth, do not forget to remove the moisture with a dry cloth.

■ Cleaning the lens

Clean the lens carefully, using a commercially-available camera lens blower, etc.

■ Care and maintenance of discs

If dirt or dust is attached to the playing surface of a disc, clean it carefully using a commercially-available CD cleaning cloth, etc.

When wiping the disc, be sure to wipe it in a radial direction. (Do not use a record cleaner for ordinary disks.)

Avoid leaving discs under direct sunlight or in a place where the temperature is high.

When a disc is not to be used for a long period of time, do not leave it in the CD player.

■ Battery life indicator

The CHARGE indicator  starts blinking at fast speed when the remaining battery life comes to around 30 minutes. In this case, replace the alkaline dry batteries with new ones or recharge the rechargeable batteries.

Refer to pages 6 and 7 for the method of replacing batteries or recharging batteries.

In case of difficulty

What appears to be a malfunction may not always be serious. Firstly, check the following items before consulting the service personnel.

Symptom	Cause	Remedy
No operation occurs when an operation button is pressed.	<ul style="list-style-type: none">● The HOLD switch is set to ON.● The power is set to OFF.● The disc is placed upside down.● Dew is condensed inside the unit (refer to page 3).● The AC adapter is unplugged.● The batteries are exhausted.	<ul style="list-style-type: none">● Set the HOLD switch to OFF.● Press the PLAY/PAUSE button to turn power ON.● Place the disc with the label side facing up.● Turn power OFF and wait for about an hour before operating the unit again.● Plug it properly.● Replace the alkaline dry batteries, or recharge the rechargeable batteries.

Symptom	Cause	Remedy
Sound is not produced from the headphones.	<ul style="list-style-type: none"> • The headphones plug is not inserted securely in the PHONES jack. • The VOLUME control is set to a too low position. 	<ul style="list-style-type: none"> • Insert securely into the PHONES jack. • Increase the volume to a suitable level that does not annoy other people.
Sound skips.	<ul style="list-style-type: none"> • The laser lens is dirty. • The disc is dirty. • The unit is placed in a place subject to strong vibration of the car. 	<ul style="list-style-type: none"> • Clean the lens. • Clean the disc. • Place it on the place less subject to vibrations, such as on the seat.

- Abnormal operation may sometimes occur when the batteries are exhausted. In such a case, turn the power OFF (by pressing the stop button twice), and replace the alkaline dry batteries or recharge the rechargeable batteries.

**For the U.S.A.
FCC WARNING:**

This equipment may generate or use radio frequency energy. Changes or modifications to this equipment may cause harmful interference unless the modifications are expressly approved in the instruction manual. The user could lose the authority to operate this equipment if an unauthorized change or modification is made.

NOTE:

This equipment has been tested and found to comply with the limits for a CLASS B digital device, pursuant to Part 15 of the FCC Rules. These limits are designed to provide reasonable protection against harmful interference in a residential installation. This equipment may cause harmful interference to radio communications, if it is not installed and used in accordance with the instructions. However, there is no guarantee that interference will not occur in a particular installation. If this equipment does cause harmful interference to radio or television reception, which can be determined by turning the equipment off and on, the user is encouraged to try to correct the interference by one or more of the following measures:

- Reorient or relocate the receiving antenna.
- Increase the separation between the equipment and receiver.
- Connect the equipment into an outlet on a circuit different from that to which the receiver is connected.
- Consult the dealer or an experienced radio/TV technician for help.

**For CANADA
DOC REGULATION**

"This digital apparatus does not exceed the CLASS B limits for radio noise emissions from digital apparatus as set out in the radio interference regulations of the Canadian department of communications."

Specifications

Tracking system	Three-beam tracking	
D/A converter	16 bit, linear	
Filter	2 times oversampling digital filter	
Frequency response	20 to 20,000 Hz, ± 1 dB	
Total harmonic distortion	0.04% (at 1 kHz)	
Output terminals	Headphone jack: 3.5 mm stereo mini-jack	
	LINE OUT jack: 3.5 mm stereo mini-jack	
Input terminal	DC IN (external power supply)	
Output level	12 mW + 12 mW (16 Ω , at 1 kHz)	
Line output	0.7 V (47 k Ω at 1 kHz)	
Power consumption	1.3 W	
Power requirement	6 V DC: provided rechargeable batteries	
	120 V AC 60 Hz (U.S.A. and CANADA, using the provided AC adaptor)	
	240 V AC 50 Hz (U.K. using the provided AC adaptor)	
	110 ~ 120 V/220 ~ 240 V AC 50 Hz/60 Hz (All other type, using the provided AC adaptor)	
Battery life	About 2 hours (continuous Repeat Play)	
	(may vary depend on charging condition)	
Dimensions (W x H x D)	131 (W) x 37.5 (H) x 158 (D) mm	
Weight	370 g (without rechargeable battery)	
Accessories	Audio connection cord	x 1
(U.S.A. and CANADA Type)	AC adaptor	x 1
	Rechargeable battery (AA)	x 4
Accessories	Audio connection cord	x 1
(U.K. and European Type)	AC adaptor	x 1
	Rechargeable battery (AA)	x 4
	Headphones	x 1
Accessories	Audio connection cord	x 1
(All other type)	AC adaptor	x 1
	Rechargeable battery (AA)	x 4

KENWOOD follows a policy of continuous advancements in development. For this reason specification may be changed without notice.

KENWOOD

PORTABLE COMPACT DISC PLAYER

DPC-92

INSTRUCTION MANUAL

KENWOOD CORPORATION



Keep this manual handy for future reference.

For your records

Record the serial number, found on the bottom of the unit, in the spaces designated on the warranty card, and in the space provided below. Refer to the model and serial numbers whenever you call upon your dealer for information or service on this product.

Model DPC-92 Serial number _____

Unpacking

Unpack the unit carefully and make sure that all accessories and cables are put aside so they will not be lost.

Examine the unit for any possibility of shipping damage. If your unit is damaged or fails to operate, notify your dealer immediately. If your unit was shipped to you directly, notify the shipping company without delay. Only the consignee (the person or company receiving the unit) can file a claim against the carrier for shipping damage.

We recommend that you retain the original carton and packing materials for use should you transport or ship the unit in the future.

CAUTION: Use of controls or adjustments or performance of procedures other than those specified herein may result in hazardous radiation exposure.

In compliance with Federal Regulations, following are reproductions of labels on, or inside the product relating to laser product safety.

Location: Bottom panel

CAUTION AGAINST HIGH TEMPERATURE

DO NOT LEAVE THIS CD PLAYER IN A PLACE SUBJECT TO HIGH TEMPERATURE, SUCH AS IN DIRECT SUNLIGHT, IN A CAR WITH THE WINDOWS CLOSED OR NEAR A HEATER. (EXCESSIVELY HIGH TEMPERATURE MAY CAUSE A CHANGE OF SHAPE, COLOR OR MALFUNCTION.)

CAUTION FOR APPLICATION
NEVER USE EITHER ANY AC OR CAR BATTERY ADAPTOR OTHER THAN AS SPECIFIED.

CERTIFIED ONLY TO CANADIAN ELECTRICAL CODE

CERTIFIÉ EN VERTU DU CODE CANADIEN DE L'ÉLECTRICITÉ SEULEMENT

ATTENTION A LA HAUTE TEMPERATURE

NE PAS LAISSER CE LECTEUR-CD DANS UN ENDROIT SUIJET À HAUTE TEMPERATURE, COMME SOUS LES RAYONS DIRECTS DU SOLEIL, DANS UNE VOITURE AUX FENÊTRES FERMÉES, OU PRÈS D'UNE SOURCE DE CHALEUR. (UNE TEMPERATURE EXTREMEMENT HAUTE PEUT DÉFORMER, DÉCOLORER L'APPAREIL, OU EN CAUSER DES FONCTIONNEMENTS DÉFECTUEUX.)

PRECAUTION

NE PAS UTILISER LES ADAPTEURS DE COURANT ALTERNATIF, OU LES ADAPTEURS DE BATTERIE D'AUTOMOBILE, QUI NE SOIENT DE NOTRE DESIGNATION.

KENWOOD
COMPACT
DISC PLAYER
DPC-92

MANUFACTURED

SERIAL NO. KC

DC 7.5V (EXCLUSIVE AC ADAPTOR)
DC 6V (LR6, "AA", AM 31X4)

KENWOOD CORPORATION
2-17-5 SIBUYA, SIBUYA-KU
TOKYO 150, JAPAN

MADE IN JAPAN

KENWOOD CERTIFIES THAT THIS EQUIPMENT CONFORMS TO DHHS REGULATIONS 21 CFR CHAPTER I SUBCHAPTER J.

Location: Inside, surface of disc lid.



CAUTION: INVISIBLE LASER RADIATION WHEN OPEN AND INTERLOCKS DEFEATED. AVOID EXPOSURE TO BEAM.
ATTENTION: RAYON LASER À L'OUVERTURE ET À L'INHIBITION DU VERROUILLAGE. ÉVITER TOUTE EXPOSITION AU FAISCEAU
VORSICHT: UNSICHTBARE LASERSTRAHLUNG TRITTS AUS WENN DECKET GEÖFFNET UND WENN SICHERHEITSVERRIEGELUNG ÜBERBRÜCKT IST. NICHT DEM STRAHL AUSSETZEN.

Before applying power of AC adaptor

Important!

USA, Canada, U.K. and Europe

Unit shipped to the above are not equipped with an AC voltage selector switch and the discussion of such a switch that follows should be disregarded.

All other countries

AC adaptor shipped to countries other than the above are equipped with an AC voltage selector switch on the bottom cover. Refer to the following paragraph for the proper setting of this switch.

AC voltage selection

AC adaptor operates on 110~120 volts or 220~240 volts AC. Before connecting the power cord to your AC outlet, make sure that the setting position of this switch matches your line voltage. If not, it must be set to your voltage in accordance with the following direction.

Note:

Our warranty does not cover damage caused by excessive line voltage due to improper setting of the AC voltage selector switch.

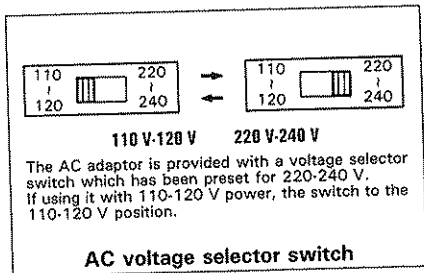
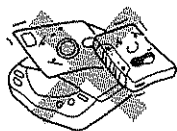

Fig. 1

WARNING:

TO PREVENT FIRE OR ELECTRIC SHOCK, DO NOT EXPOSE THIS APPLIANCE TO RAIN OR MOISTURE.

Precautions for use



- This unit uses a magnet. Do not place a floppy disk, cassette tape, etc. on the unit.

To maintain the high performance and reliability of this unit, avoid using or storing it in the following conditions.



- Dusty places.

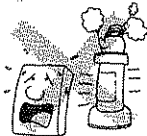

- Near heat sources such as stoves, etc.

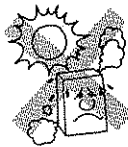

- Places exposed to direct sunlight, especially in a closed car.

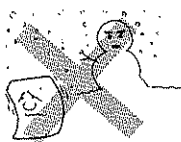

- Extremely cold places.

For United Kingdom

The mains plug must be removed from the wall socket prior to any internal examination.

Important

The wires in this mains lead are coloured in accordance with the following code:

Blue Neutral
Brown Live

The wires in this mains lead must be connected to the terminals in the plug as follows:

Wire colour	Plug terminal marking
Blue	N or Black
Brown	L or Red

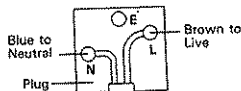

Notes:

- 1) If a 13-amp plug is used, this must be fitted with a 5-amp fuse.
- 2) If a 3-pin plug with earthing contact is used, no wire must be connected to the E terminal.

WARNING NOTICE:

IN MOST CASES IT IS AN INFRINGEMENT OF COPYRIGHT TO MAKE COPIES OF TAPES OR DISCS WITHOUT THE PERMISSION OF THE COPYRIGHT OWNERS. ANYONE WISHING TO COPY COMMERCIALY AVAILABLE TAPES OR DISCS SHOULD CONTACT THE MECHANICAL COPYRIGHT PROTECTION SOCIETY LIMITED OR THE PERFORMING RIGHTS SOCIETY LIMITED.

■ Condensation (dew)

- When the unit is placed in a humid place or just after heater is turned on, condensation may form inside the unit and unit may not function correctly. At that time, press the [■] (STOP) button twice to turn off the unit (when the button is pressed once, the unit only enters stop mode), leave the unit for about 1 hour, then load a disc and start play.

■ Using headphones

- CD players have such a low noise level that listeners often tend to overly increase the sound volume. Set the sound volume to an appropriate level to protect your ears from excessive shock.
- For your safety and the safety of others, do not use headphones while driving a car or other type of vehicle.
- Be careful not to fall asleep while listening to music using headphones.
- Continuous use of headphones for long periods may hurt your ears.

Fig. 1

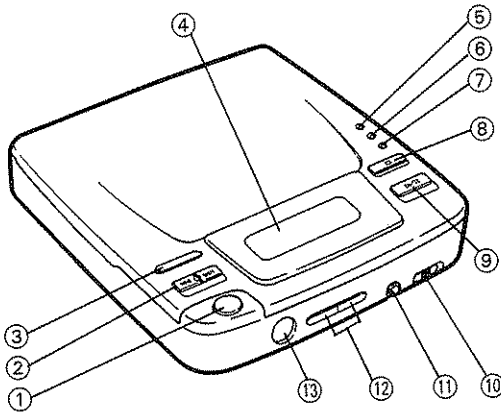
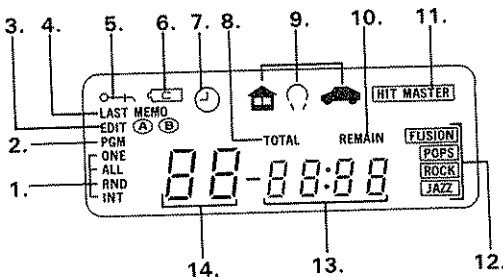

Fig. 2



Rear side

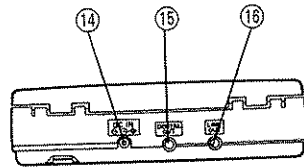
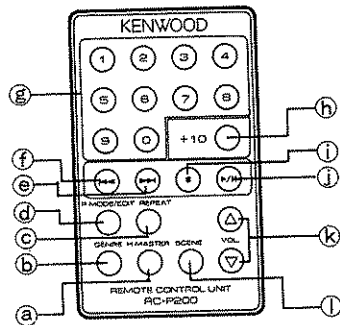

Fig. 3



Controls and connectors <Fig. 1>

- ① [OPEN] button
- ② [▶▶] [◀◀] SKIP, SEARCH button
- ③ [REPEAT] button
- ④ Display
- ⑤ TIME BUTTON
Time display indicator selector switch/TIMER alarm button
- ⑥ [SCENE] select button
- ⑦ [GENRE/CHG] GENRE select/CHARGE button
- ⑧ [■]/[OFF/CHG] button
STOP/POWER OFF/CHARGE button
- ⑨ [▶ II]/[ON] button
PLAY/PAUSE/POWER ON button
- ⑩ [HOLD/LAST MEMO] select switch
- ⑪ [PHONES] jack
- ⑫ [VOLUME] UP/DOWN button
- ⑬ Remote control receptor
- ⑭ [DC IN] jack
- ⑮ [DIGITAL OUT] jack
- ⑯ [LINE OUT] jack

Display section <Fig. 2>

1. [REPEAT] mode indicators
(ONE) "REPEAT-one" play
(ALL) "REPEAT-all" play
(RND) "RANDOM" play
(INT) "INTRODUCTION" play
2. [P.MODE] indicator
3. [EDIT] mode indicator
4. [LAST MEMO] indicator
5. [HOLD] indicator
6. It blinks when the batteries are running out. It also blinks at relatively long interval during recharging.
7. Timer Alarm Indicator
8. Total elapsing time and total remaining time.
9. [SCENE] indicator
10. [REMAINING TIME] indicator
11. [HIT MASTER] indicator
12. [GENRE] indicator
13. Elapsing time, total-recording time and remaining time display.
14. Track number display

■ Wireless Remote Control Unit <Fig. 3>

- Buttons marked with an asterisk (*) will perform the same function as those on the player. Buttons without an asterisk are buttons only on the remote control.
- This remote control is not fitted with a player power button.
- Before use, pull out and remove battery preserver sheet located at the rear panel.
- Replacement batteries for the remote control are available at retail stores. Ask for CR2025 type batteries.

- Ⓐ [H.MASTER] HIT MASTER button
- Ⓑ * [GENRE] button
- Ⓒ * [REPEAT] button
- Ⓓ [P.MODE/EDIT] PROGRAM/EDIT button
- Ⓔ * [▶▶] button
- Ⓕ * [◀◀] button
- Ⓖ Direct music selection button (0~9)
- Ⓗ Direct music selection button (+ 10)
- Ⓘ * [■] STOP button
- Ⓝ * [▶ II] PLAY/PAUSE button
- Ⓚ * [VOL.] Volume UP/DOWN button
- Ⓛ * [SCENE] Select button

■ Remote Control Unit Operating Range

- The diagram below indicates the operating range of this remote control unit.

Caution:

- Allow at least one second between pressing keys when using the remote control.
- When the compact disc player is placed in direct sunlight the user may experience difficulty using the remote control.

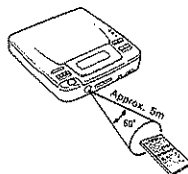

Power source

■ Use in the following method:

Household AC Power Source	Use the provided AC adaptor.
Alkaline dry Battery	Use size AA alkaline dry batteries which are available in the general market.
Rechargeable Battery (Provided)	Charge with the provided AC adaptor before use.
Car Battery	Use the optional car-battery adaptor DC-C6 (exclusive for 12-V car).

■ How to use the main unit with the provided AC adaptor < Fig. 4 >

- When this provided AC adaptor is used, the power source can be supplied from household outlets. Insert the plug of the AC adaptor into the [DC-IN] terminal, then connect the AC adaptor to a household outlet.
- Pull out the AC adaptor from the outlet when it is not in use. Conduct insertion into or pulling out from the power source terminal after pressing the STOP [■] button twice in order to turn the main unit into "POWER OFF" condition.

Fig. 4

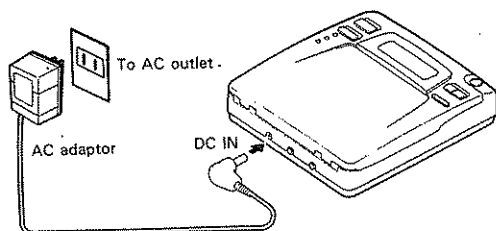

■ How to use the unit with the provided rechargeable batteries or alkaline dry batteries

The usable rechargeable batteries are only the provided rechargeable batteries. Generally marketed rechargeable batteries and manganese dry batteries cannot be used.

● How to Insert the batteries into the battery compartment < Fig. 5 >

① Open the battery cover.

② Insert the batteries.

Insert the four provided rechargeable batteries or alkaline dry batteries into the battery compartment surely by paying attention for correct polarity.

③ Close the battery cover.

Fit the hook of battery cover into the specified position.

Be sure to fit it into the specified position until it clicks and gets locked.

Charge the provided rechargeable batteries for 6 hours, if you use them for the first time. Do not use the rechargeable batteries together with the dry batteries. Be sure to replace the 4 batteries with the same type ones simultaneously.

Fig. 5

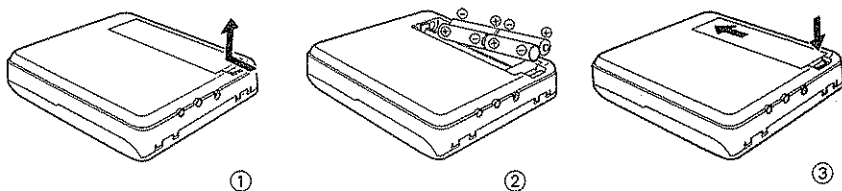

● How to Recharge < Fig. 6 >

Turn the Power off and insert provided rechargeable batteries into the battery compartment, then connect an AC adaptor to the main unit. Press the [OFF/CHG] button to switch the power OFF. Then, while holding the [GENRE/CHG] button depressed, press the [OFF/CHG] button again. During recharging, the  mark blinks slowly.

Recharging is canceled automatically by the built-in and 6-hour timer when recharging is completed.

1. Recharging will be canceled when PLAY/PAUSE [▶ ||] button or STOP [■] button is pressed during recharging. Other operations cannot be conducted.
2. The CHARGE button do not functions when the HOLD switch is turned ON.
3. Recharging is canceled when the AC-adaptor plug is pulled out an outlet while recharging is being conducted, or when power supply is cut.

Fig. 6

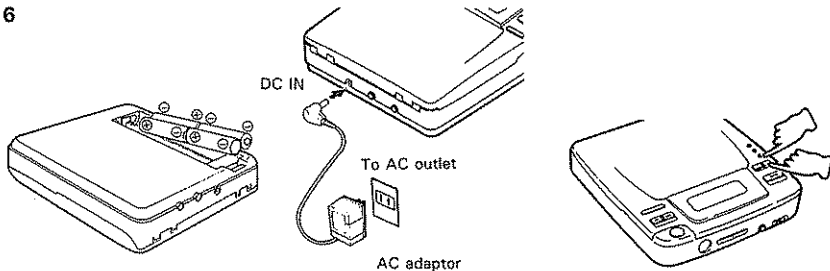

● **How to Recognize the Recharging Time**

In the normal use, 4 hours of recharging allows continuous play for about 2 hours.

Recharge them for about 6 hours, however, if they are not used for a long period of time.

● **How to make batteries stand up to long use**

If recharge is repeated for the provided batteries, where as the power of batteries is still remained, the batteries may not be recharged enough as their property. In such a case, use up the power of them before conducting recharging, which allows them for normal recharging.

● **Service Life of Rechargeable Battery**

Rechargeable battery has a life.

After about 500 times of recharging, its performance (operating time) is halved as compared to a new battery. If operating time shortens considerably although you have charged your battery properly, four rechargeable batteries for replacement.

Cautions:

- Do not recharge the manganese or alkaline dry batteries.
- Be sure to use only the provided AC adaptor for recharging. It is dangerous if you use other kind of AC adaptor.
- Avoid adverse recharging or short circuit. They result in causing of such troubles as deterioration of rechargeable batteries and generation of heat.
- Do not disassemble or modify it by yourself.
- Do not touch the CD player or AC adaptor with wet hands.

■ **Battery life indicator**

The CHARGE indicator  starts blinking at fast speed when the remaining battery life comes to around 30 minutes. In this case, replace the alkaline dry batteries with new ones or recharge the rechargeable batteries.

Refer to pages 7 and 8 for the method of replacing batteries or recharging batteries.

Simple care and maintenance

■ **Cleaning the cabinet**

When the cabinet gets dirty, wipe it with a dry cloth. If the stain is so serious that it cannot be removed with a dry cloth, moisten the cloth with a small amount of water. After wiping with the moistened cloth, do not forget to remove the moisture with a dry cloth.

■ **Cleaning the lens**

Clean the lens carefully, using a commercially-available camera lens blower, etc.

■ **Care and maintenance of discs**

If dirt or dust is attached to the playing surface of a disc, clean it carefully using a commercially-available CD cleaning cloth, etc.

When wiping the disc, be sure to wipe it in a radial direction. (Do not use a record cleaner for ordinary discs.)

Avoid leaving discs under direct sunlight or in a place where the temperature is high.

When a disc is not to be used for a long period of time, do not leave it in the CD player.

Listening through headphones <Fig. 7>

- Connect the headphone plug with the "PHONES" jack. Conduct the pull-in/out operation of the jack during Power is OFF.
- Adjust the volume with the VOLUME control.

Fig. 7

Notes:

- Keep the plug of headphone clean all the time. Non-clean plug may cause noise.
- Avoid using the headphone when you drive a car and so on for traffic safety.
- Be careful not to fall asleep with the headphone on.

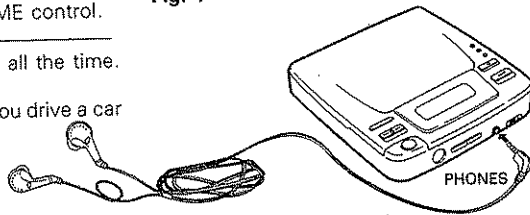

As a Compact Disc contains very little noise, a sudden loud sound could be output if the VOLUME control is adjusted too high: this could cause serious damage to your ears.

Playback through a home audio system (analog input)

■ Playback using the "LINE OUT" output <Fig. 8>

- Using the provided audio connection cord, connect the 3-pin miniplug to "LINE OUT" terminal of this unit. Connect the other end of the cord to the amplifier's external input jacks (AUX jacks, TAPE PLAY jacks, etc.). Connect the red plug to the "R" (right channel) input jack and the white plug to the "L" (left channel) input jack.
- Set the player volume control to maximum.
- Adjust the sound volume using the amplifier's volume control.
- When the direct input from the main unit to a tape deck is to be made, adjust the volume with volume-level adjuster (REC LEVEL) of the tape deck.

Caution:

- Before making connections, be sure to turn the amplifier power off.

Do not connect the main unit to the PHONO terminal of the amplifier.

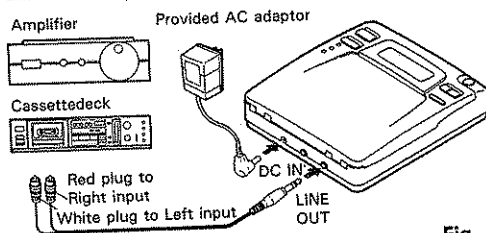

Fig. 8

Playback through a home audio system (COAXIAL digital input)

- Using a digital connection cord optionally available in audio stores, connect the DIGITAL OUT jack of this unit with an amplifier equipped with a coaxial digital input jack.
- Adjust the sound volume using the amplifier's volume control.

Caution:

- Before making connections, be sure to turn the amplifier power off.

- Also use an adapter plug for input connection to the portable DAT.

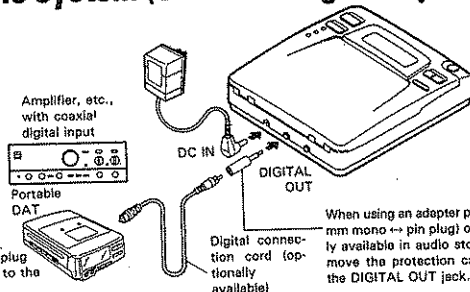

When using an adapter plug (3.5 mm mono \leftrightarrow pin plug) optionally available in audio stores, remove the protection cap from the DIGITAL OUT jack.

CD playback in an automobile < Fig. 9 >

■ Use in the car audio cassette adaptor CAC-1

- When the power source is taken from a cigar socket of a car, use the car battery adaptor DC-C6. It allows you to enjoy listening to music for a long time without worrying about the battery consumption.
- Insert the plug of car audio cassette adaptor CAC-1 into the "LINE OUT" terminal of the main unit. Insert the CAC-1 to the car component deck, and turn the car component deck into the PLAY mode.
- Adjust the sound volume using the volume control of the car stereo.

Notes:

- **Since car battery adaptors available in the market have different polarity and voltage, they may result in troubles.**
(Be sure not to use a car battery adaptor other than the DC-C6.)
- In case the unit is used in a car, install it taking the safety in consideration, so that it does not interfere with the driving operations.
- **The CAC-1 cannot be used with some car audio cassette models.**
- **Do not leave the unit in a closed automobile where the temperature is expected to be high.**
- Place the unit on a soft place where automobile vibrations are not easily transmitted.
- If any sound skipping occurs due to vibrations, turn on the [HOLD] switch to reduce the sound skipping.

Fig. 9

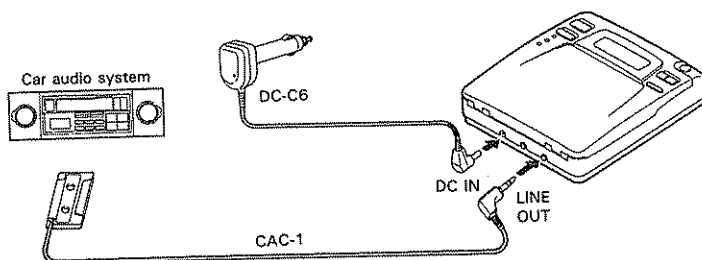

- * The DC-C6 Car Battery Adaptor is an optional accessory with the USA, Canada, UK and Europe type models.
- * The CAC-1 Audio Cassette Adaptor is an optional accessory with the UK and Europe type models.

8 cm CD single can also be played

This unit can play 8 cm CD singles directly without using an adaptor.

Caution:

- Do not use an adaptor sold for other models (otherwise the CD or this unit may be damaged).

How to play (Manual play)

Manual Play (Basic Operation)

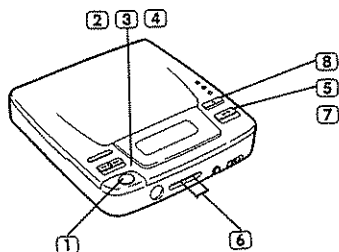

Leave the HOLD/LAST MEMO switch turned OFF.

- 1 Push the OPEN button.
- 2 Open the lid: Lightly lift the lid near the OPEN button.
- 3 Insert the disk: Be sure to keep the label side of the disc upward.
- 4 Close the lid.
- 5 Push the PLAY/PAUSE [▶ II] button: The unit starts playing automatically after scanning the data of the disc.
- 6 Adjust the volume.

When PLAY/PAUSE [▶ II] button is pressed to POWER ON.



When the unit starts playing automatically.

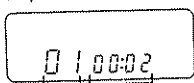

In the event that data is not read or a disc is not inserted. (It will turn out to be POWER OFF after elapsing of three minutes.)

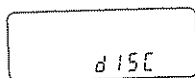

PAUSE MODE

Track being played

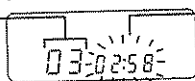

Playback time blinks here.

STOP MODE

Total number of tracks

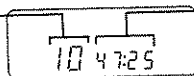

Total playing time

To operate temporary stop (pause)

- 7 Push PLAY/PAUSE [▶ II] button: If you press it once more, the unit starts playing from the paused position.

To stop

- 8 Push the STOP [■] button:
 - If the STOP [■] button is pressed once, the unit is put in the stop mode. If it is pressed once again, the unit is turned out to be POWER OFF.
 - If the stop mode lasts for 3 minutes or more, the unit is turned out to be POWER OFF.

Notes:

- If the HOLD switch is being turned ON, PLAY/PAUSE [▶ II] operation cannot be activated even the button is pressed.
- When the [HOLD/LAST MEMO] switch is set to LAST MEMO, the play starts at the beginning of the track being played before the unit stops.
- If the lid is open, all the functions do not work.
- If the PLAY/PAUSE [▶ II] button is pressed during the stop mode, the unit starts playing from the first track.
- When the [OPEN] button is pressed with the power is supplied, the settings of the volume level, [GENRE] and [SCENE] are stored and others are erased.
- When the music is played until the final track and the player has naturally entered the STOP Mode, it indicates the total playing time.
- Be sure not insert the disc up side down. If the disc is inserted into the unit with reverse side up, the unit can not start playing.
- Do not insert anything other than the disc into the disc tray.

■ Volume Control

Adjust the [VOLUME] level by pressing the "UP" and "DOWN" buttons.

- The player will set itself to -16dB (approximately 1/6 maximum volume) as soon as the power is switched on.
- The player will reset itself to -16dB when the power is switched off.
- Raise the volume by pressing the "UP" button once for each unit increase in sound.
- Lower the volume by pressing the "DOWN" button once for each unit decrease in sound.
- Keep the button held down for larger changes in the volume level.
- Correct operation of the above steps will change the volume level output from both [PHONES] and [LINE OUT].

■ **To skip to the beginning of desired track (Skip feature, ◀▶▶), to search in the forward or backward direction (Search feature, ◀▶▶)**

- The skip function is activated with one press of button and the search function is activated with continuous press of button.
- Operate during play (Basic Operations 5, 6), or stop mode (Basic Operation 8).

9 **To skip to the beginning of the track being played:**

Tap the ◀▶▶ button for an instant.

To skip to the beginning of the next track:

Tap the ▶▶▶ button for an instant.

- When you wish to skip back to the previous music, press the ◀▶▶ button once more.
- The first music is caused to play if ▶▶▶ button is pressed while the last music is being played.
- If you press ◀▶▶ button during the stop mode, the last music is activated to play.

10 **How to operate the quick return with the main unit:**

Push ◀▶▶ button continuously.

How to operate the quick traverse:

Push ▶▶▶ button continuously.

- If you release the quick return and quick traverse buttons, the unit plays the music from that position.
- If an operation is made during the pause mode, the music is paused at the position where the button is released.

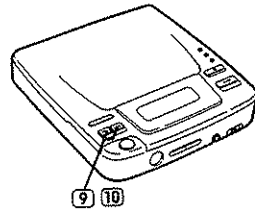

How to Play (Direct Play)

■ Direct Play

- **This function can be operated only by the remote controller. (RC-P200)**
- By just pressing the direct music selection button, the selected music is played immediately.
- Operation can be performed during the play or stop mode (when the unit is stopped with disc inserted).
- If the number larger than the number of musics in the disk is selected, it is not accepted.

11 **In case of selecting either one of Musics 1 through 9:**

Push either of Buttons 1 through 9.

In case of selecting either one of Musics 20 and beyond:

Push either one of Buttons 0 through 9 after pressing the +10 Button twice.

How to play (Repeat play)

Repeat play

- If the REPEAT button on the main unit is pressed during play or stop mode (basic-operation ⑧), repeat play will be activated.

Every time the button is pressed

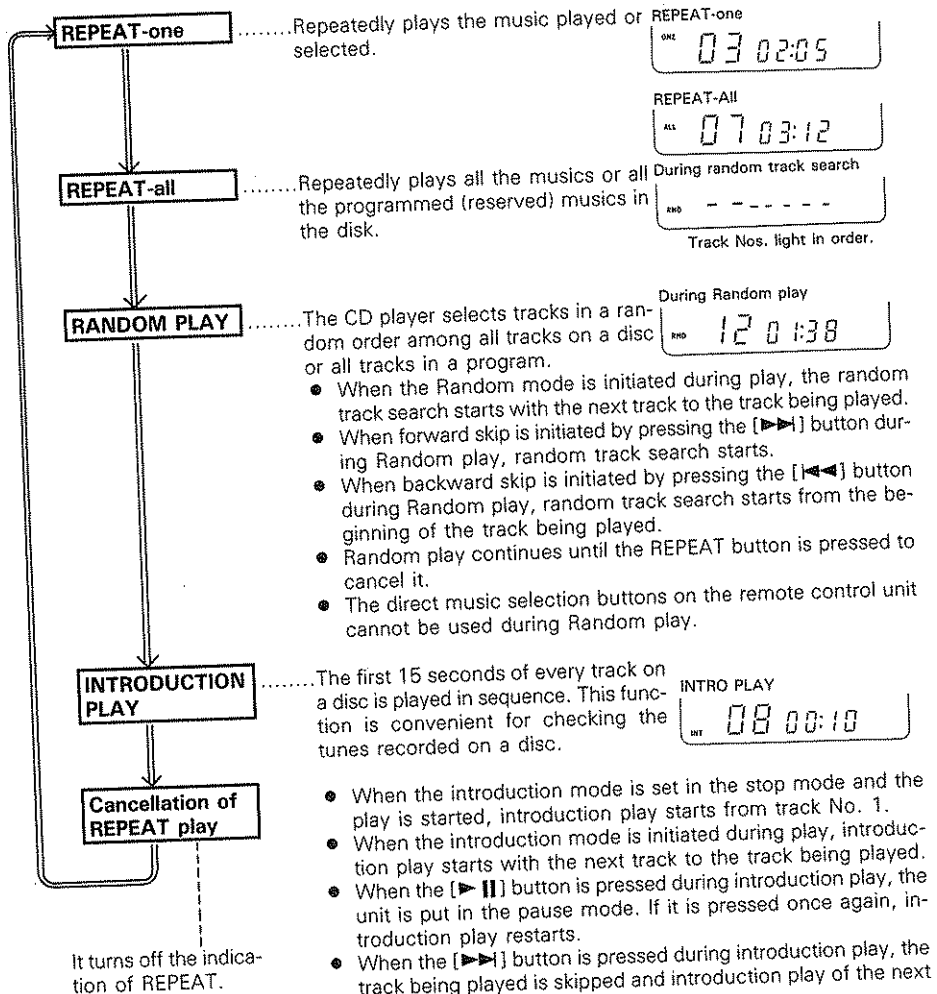
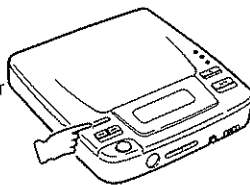

How to Stop Play
Press the STOP [■] button on the main unit.

How to Play (Program Play)

- Operate during the stop mode (Basic operation **8**). It cannot be operated if the mode is in other than the stop mode.
- 24 favorite music's can be programmed (reserved) in the order you like to listen to.
- After completion of the programming (reservation), play is activated if **[▶ II]** button is pressed.

■ How to Program with Direct Music Selection (Remote controller only)

(Basic Operations **1** - **6** are omitted.)

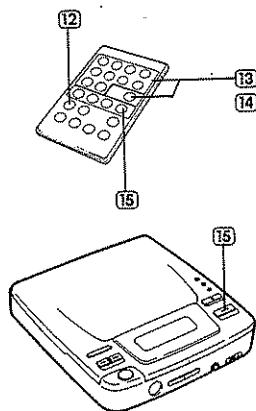

- 12** Push **P.MODE/EDIT** button on the remote controller.
- It enters the program input mode.

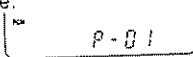

- 13** Select the track (music):
(Select the music with the direct music selection button on the remote controller. Follow the procedures in **11**.)
Reservation is completed by selecting the music.
- Completion of reservation of Music 1 (P-01).



- 14** Select the track (music) (from Program number 2, 3, ... 24):
- Repeat the operation in **13**. By repeating music selection, the reservation can be made one after another.
- 15** Push **PLAY/PAUSE [▶ II]** button: starts to play.
- Operate with the HOLD/LAST MEMO. switch in the OFF condition.

■ How to program with the SKIP button

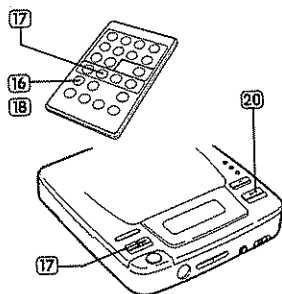

- 16** Push **P. MODE/EDIT** button on the remote controller.
- Enters the program input mode (the same operation as in **12**).
- 17** Select with the Skip/Search [**◀▶**] button (Program number 1):
- 18** Push the **P. MODE/EDIT** button.
- 19** Select the music (from Program 2, 3, ... 24):
- Repeat the operation in **17** and **18**.
- 20** Push **PLAY/PAUSE [▶ II]** button: starts to play.
- Operate with the HOLD/LAST MEMO. switch in the OFF condition.

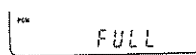

- The maximum number of input tracks for program is 24. The following indication is shown after those 24 tracks are input.
- During the programmed play, the unit is in the auto space mode. Then, the four-second pause is inserted between the tracks.
- If the **STOP [■]** button is pressed during programming, the player will switch to the program standby mode.
If the **STOP [■]** button is pressed when the player is in the program standby mode, the program will be cancelled.
- If the skip [**◀▶**] button is pressed during the programmed play, skip search can be made only with the programmed track.
- When the program is called during the program standby mode and the **PLAY/PAUSE [▶ II]** button is pressed with **HOLD/LAST MEMO. OFF** (See Page 16), the player will play from the first track programmed, not the track whose number is indicated now.

■ Introduction program entry

This function allows to program only desired tracks while listening to the beginning of every track by Introduction play (refer to page 13).

- The direct music selection buttons on the remote control unit cannot be used.

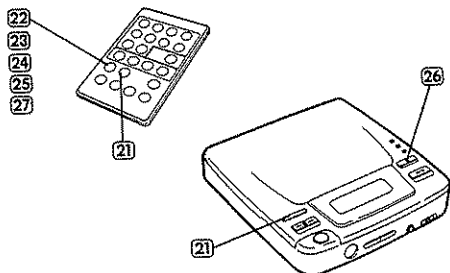

- ②① Push the REPEAT button Four times.

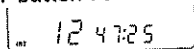

- ②② Push the P. MODE/EDIT button on the remote controller to start the INTRODUCTION play.

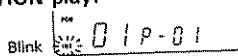

- ②③ When a track you want to program is played, press the P.MODE/EDIT button.

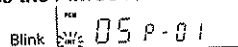

- During Introduction program entry, the ►► and ◀◀ buttons can be used to skip tracks as required.
- The search function (FF/REV) and the pause function do not work during Introduction program entry.

■ Confirmation of the programmed contents

- This function can be operated when the disc is programmed and stopped.

- ②④ Push the P.MODE/EDIT button on the remote controller.

- Indicates the Program number 1.

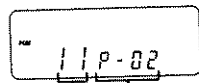

Track programmed Program No.

- ②⑤ If the P. MODE/EDIT button is pressed repeatedly:

- Then the programmed contents are indicated in order.
- If the music orders are indicated until the last programmed track, the indication returns to Program number 1.

■ How to cancel all the programs

- ②⑥ Put the unit to POWER OFF or open the lid:

- Push the STOP [■] button once when the musics are is programmed and the disc is stopped in order to enter the unit into the stop mode, or press the STOP [■] button twice during play in order to put the unit to POWER OFF.

■ How to change the contents of the program

- ②⑦ Call the program number to be changed by pressing the P. MODE/EDIT button on the remote controller.

Example:

When you wish to change the music in Track 11 of the Program Number 2 to Track 8, call the Program Number 2 by pressing the P. MODE/EDIT button.

- ②⑧ Enter the track number either by using the numeric keys, or by using the ►► and ◀◀ buttons and pressing the P.MODE/EDIT button.

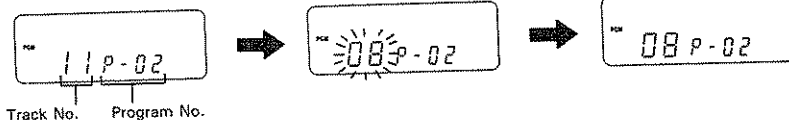

EDIT Function

EDIT function is the function to edit by fully making use of the recordable time of a tape when a CD is dubbed into a tape.

- In the stop mode, you can select EDIT modes by pressing the P.MODE/EDIT button twice.

29 Push the P.MODE/EDIT button on the remote controller twice.

- In the program stand-by mode, this operation can not be made.

30 Input the accommodating time of the tape with the direct music selection buttons (0 - 9) and (+ 10).

31 Push the P.MODE/EDIT button.

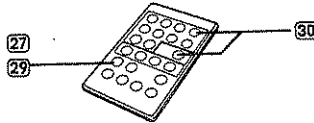

- Each tracks to be recorded is assigned automatically to side **A** or side **B** of tape, and the following displays appear.

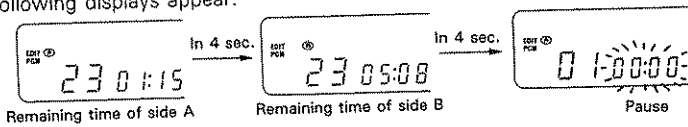

- Arrange the musics from the initial music of a CD in order so as to accommodate them within the designated accommodating time of Side A of a cassette tape, and select the most suitable music within its remaining time for the last music.
- Arrange the musics in order for Side B excluding the musics programmed into Side A, and select the most suitable music for the last music on Side B.
- When all the musics are recorded into Side A, "no-FILE" is indicated on the display and pause is activated at the first music on Side A.
- When the recording of Side A is completed, the unit enters the pause mode at the beginning of Side B.
- When the playing operation is completed up to the end of Side B, the normal stop mode is automatically activated.

Convenient functions

■ Prevention of misoperation [HOLD]/Reduction of sound skip [Anti shock]/Last memory function

- This unit has the HOLD function to prevent misoperation, the anti-shock function to reduce the sound skipping and the LAST MEMO. function to memorize the musics until the power is turned off. When the unit is used in the car or elsewhere where there is big vibrations, the sound skipping is reduced.

Turn on the HOLD switch:

- If the "HOLD" is turned on in the POWER OFF mode, the unit will not be turned to the POWER ON mode even though the PLAY/PAUSE button is pressed.
- If the "HOLD" is turned on during the play, the button switches other than the "OPEN" button can not be operated.
- This operation can also be carried out with the remote control unit.

When the LAST MEMO. switch is turned on, the following operations are made:

- When the power is turned on from the off condition, the player starts to play the track from the beginning part of the track where the present location of the pick-up is read.
- If the STOP [■] button is pressed and the PLAY/PAUSE [▶||] button is pressed again, the player starts to play from the beginning part of the stopped track. (When it is paused at the near end of a track, it may start playing from the beginning part of the following track.)
- If the SKIP button [◀◀] is pressed during the stop mode, the player starts to play the track previous to the track for which the STOP [■] button is pressed.
- If the SKIP button [▶▶] is pressed during the stop mode, the player starts to play the track next to the track for which the STOP [■] button is pressed.
- The Last track memory function also work even in the Hold ON status.

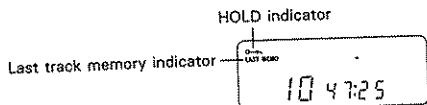

TIME Button

Press the [TIME] button both for information on track times and to use the TIMER alarm. Each press will move the operation sequence in the order shown below.

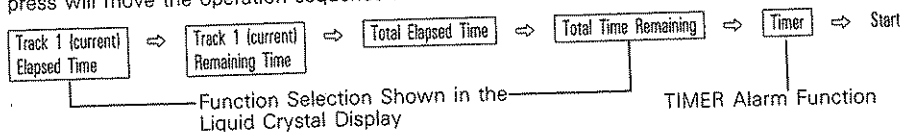

- The operating mode in which the player is currently set will determine the type of track time information displayed. These display sequences are shown below.

■ Liquid Crystal Display Sequence

• **When the player is in PLAY or PAUSE mode**

Track 1 (current) Elapsed Time ⇌ Track 1 (current) Remaining Time ⇌ Total Elapsed Time ⇌ Total Remaining Time ⇌ TIMER ⇌ Start
 (Display) (REMAIN) light on (TOTAL) light on (TOTAL) (REMAIN) light on.

• **When the player is in the STOP mode**

Total Remaining Time Display (Total Number of Tracks Display) ⇌ TIMER ⇌ Start

• **When the player is in the PROGRAM PLAY mode**

The display will show the Total Elapsed Time and the Total Remaining Time for only those tracks which have been programmed.

• **Random Play**

Track 1 (current) Elapsed Time ⇌ Track 1 (current) Remaining Time ⇌ TIMER display ⇌ Start

• **During PROGRAM ENTRY mode**

Track 1 (current) Remaining Time: shows the time remaining of the track now being entered (track number will light up).

Total Remaining Time: shows the total time remaining before the track being entered and the tracks already entered finish.

- **40 or more tracks: note that track times may not be shown when 40 or more tracks have been entered.**

TIMER Alarm

This player has a built in **TIMER** alarm. The **TIMER** alarm lets the user enjoy music while keeping an ear on the time.

1. Press the **TIME** button and set so that " ⌚ " lights in the display.
Press 4 times when starting from the very beginning.
2. Adjust the alarm period by pressing the **▶▶** and **◀◀** buttons.
The alarm period is initially set for 2 hours. Each button press will adjust the period by 1 minute intervals.
Shorten the time period using the **◀◀** button; lengthen period using the **▶▶** button. The **TIMER** can be set for periods of up to 2 hours.
3. Activate the **TIMER** by pressing the **TIME** button after setting the timer period.
The display will return to the original display sign and will light up.
 - An alarm will ring for 10 seconds when the timer period set by the user has elapsed.
 - Turn alarm off during ringing by pushing any button.
When the alarm is ringing, every button is an alarm OFF button; normal button functions cannot be used.
 - If the alarm is not switched off by pressing a button, it will ring for 10 second intervals every alternate minute.
When the alarm rings 3 times, the power is automatically turned off.
 - The timer setting will be canceled if the power is switched off.

HIT MASTER

The **HIT MASTER** function enables the volume level of the vocal parts of digitally recorded compact discs to be lowered.

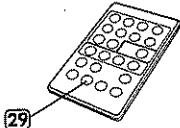

- 29** When **(H.MASTER)** button is pressed once, the **HIT MASTER** function is activated.
When the button is pressed again, the function is cancelled.

- Note that the **[HIT MASTER]** function may not be used simultaneously with either **[GENRE]** and/or the **[SCENE]** functions.
Both **[GENRE]** and **[SCENE]** functions will be canceled automatically when the **[HIT MASTER]** function is selected.

Sound Quality Adjustment

This player incorporates a built-in digital signal processor (**DSP**). The **DSP** allows the user to use an operation sequence to select sound quality settings appropriate for both the music genre and the place where the music will be heard. These controls must be selected prior to playing.

■ **GENRE** button

Pressing the **GENRE** button will display the operation sequence shown below.
NORMAL ⇄ FUSION ⇄ POPS ⇄ ROCK ⇄ JAZZ ⇄ NORMAL

- NORMAL: Sound without enhancement, sound as it is; appropriate for classical music.
 FUSION: Sound projecting a broad central range suitable for fusion and similar music.
 POPS: Clear and crisp sound appropriate for popular music.
 ROCK: Sound with punch and clarity from middle to low ranges through to high sounds.
 JAZZ: Clear sound with a full and broad treble range.

■ SCENE Button

Pressing the SCENE button will display the operation sequence shown below.

NORMAL ⇔ HOME ⇔ HEADPHONE ⇔ CRUISING ⇔ NORMAL

- NORMAL: Natural, unprocessed sound.
 HOME: Wide and generous sound for listening to music indoors.
 HEADPHONE: Sound which avoids unnatural noise arising from using headphones.
 CRUISING: To reduce the level difference between high and low levels for listening in a noisy environment.

- When set to the CRUISING position, the [GENRE] setting will return to NORMAL.
- When set to [GENRE] while in the CRUISING position, the CRUISING function will be canceled and return to NORMAL.
- When the [HIT MASTER] function is entered, GENRE and SCENE circuits will both return to NORMAL.

In case of difficulty

What appears to be a malfunction may not always be serious. Firstly, check the following items before consulting the service personnel.

Symptom	Cause	Remedy
No operation occurs when an operation button is pressed.	<ul style="list-style-type: none"> • The HOLD switch is set to ON. • The power is set to OFF. • The disc is placed upside down. • Dew is condensed inside the unit (refer to page 4). • The AC adaptor is unplugged. • The batteries are exhausted. • The headphone plug is dirty. 	<ul style="list-style-type: none"> • Set the HOLD switch to OFF. • Press the PLAY/PAUSE button to turn power ON. • Place the disc with the label side facing up. • Turn power OFF and wait for about an hour before operating the unit again. • Plug it properly. • Replace the alkaline dry batteries, or recharge the rechargeable batteries. • Clean the plug.
Sound is not produced from the headphones.	<ul style="list-style-type: none"> • The headphones plug is not inserted securely in the PHONES jack. • The VOLUME control is set to a too low position. 	<ul style="list-style-type: none"> • Insert securely into the PHONES jack. • Increase the volume to a suitable level that does not annoy other people.
Sound skips.	<ul style="list-style-type: none"> • The laser lens is dirty. • The disc is dirty. • The unit is placed in a place subject to strong vibration of the car. 	<ul style="list-style-type: none"> • Clean the lens. • Clean the disc. • Place it on the place less subject to vibrations, such as on the seat.

- Abnormal operation may sometimes occur when the batteries are exhausted. In such a case, turn the power OFF (by pressing the stop button twice), and replace the alkaline dry batteries or recharge the rechargeable batteries.

**For the U.S.A.
FCC WARNING:**

This equipment may generate or use radio frequency energy. Changes or modifications to this equipment may cause harmful interference unless the modifications are expressly approved in the instruction manual. The user could lose the authority to operate this equipment if an unauthorized change or modification is made.

NOTE:

This equipment has been tested and found to comply with the limits for a CLASS B digital device, pursuant to Part 15 of the FCC Rules. These limits are designed to provide reasonable protection against harmful interference in a residential installation. This equipment may cause harmful interference to radio communications, if it is not installed and used in accordance with the instructions. However, there is no guarantee that interference will not occur in a particular installation. If this equipment does cause harmful interference to radio or television reception, which can be determined by turning the equipment off and on, the user is encouraged to try to correct the interference by one or more of the following measures:

- Reorient or relocate the receiving antenna.
- Increase the separation between the equipment and receiver.
- Connect the equipment into an outlet on a circuit different from that to which the receiver is connected.
- Consult the dealer or an experienced radio/TV technician for help.

Specifications

Tracking system	Three-beam tracking	
D/A converter	Advanced interpolative 1 bit D/A converter	
Frequency response	20 to 20,000 Hz, ± 1.0 dB	
Total harmonic distortion	0.01% (at 1 kHz)	
Output terminals	Headphone jack: 3.5 mm stereo mini-jack LINE OUT jack: 3.5 mm stereo mini-jack DIGITAL OUT jack: 3.5 mm MONO mini-jack	
Input terminal	DC IN (external power supply)	
Output level	15 mW + 15 mW (16 Ω , at 1 kHz)	
Line output	0.8 V (47 k Ω at 1 kHz)	
Power consumption	2.4 W	
Power requirement	6 V DC; (Alkaline dry batteries AA $\times 4$) 120 V AC 60 Hz (U.S.A. using the provided AC adaptor) 240 V AC 50 Hz (U.K. using the provided AC adaptor) 110 ~ 120 V/220 ~ 240 V AC 50 Hz/60 Hz (All other type, using the provided AC adaptor)	
Battery life	About 2 hours (continuous Repeat Play) (when using provided rechargeable batteries) (may vary depend on charging condition) Approximately 4 hours of continuous play (when using ordinary alkaline dry batteries)	
Dimensions (W \times H \times D)	130 (W) \times 33.5 (H) \times 145 (D) mm	
Weight	495 g (without rechargeable battery)	
Accessories	Audio connection cord	$\times 1$
(U.S.A. Type)	AC adaptor	$\times 1$
	Rechargeable battery (AA)	$\times 4$
	Wireless remote controller (RC-P200)	$\times 1$
	Car audio cassette adaptor (CAC-1)	$\times 1$
Accessories	Audio connection cord	$\times 1$
(U.K. Type)	AC adaptor	$\times 1$
	Rechargeable battery (AA)	$\times 4$
	Wireless remote controller (RC-P200)	$\times 1$
Accessories	Audio connection cord	$\times 1$
(All other type)	AC adaptor	$\times 1$
	Rechargeable battery (AA)	$\times 4$
	Wireless remote controller (RC-P200)	$\times 1$
	Car audio cassette adaptor (CAC-1)	$\times 1$
	Car battery adaptor	$\times 1$
	Carrying case	$\times 1$
	Headphones	$\times 1$

This unit does not conform to the rules and regulations in Europe (except the U.K.) and Canada.

KENWOOD follows a policy of continuous advancements in development. For this reason specification may be changed without notice.

KENWOOD

DPC-81

PORTABLE COMPACT DISC PLAYER
INSTRUCTION MANUAL
(PAGE6-20)

LECTEUR CD PORTABLE
MODE D'EMPLOI
(PAGE21-35)

REPRODUCTOR DE DISCOS COMPACTOS PORTATIL
MANUAL DE INSTRUCCIONES
(PAGINA36-50)

KENWOOD CORPORATION

Keep this manual handy for future reference.

For your records

Record the serial number, found on the bottom of the unit, in the spaces designated on the warranty card, and in the space provided below. Refer to the model and serial numbers whenever you call upon your dealer for information or service on this product.
Model DPC-81 Serial number _____

©PRINTED IN JAPAN B60-0145-08(K,P,M,Y)(T)
91/12 11 10 9 8 7 6 5 4 3 2 1 90/12

Precautions for use

To maintain the high performance and reliability of this unit, avoid using or storing it in the following conditions.

Précautions à l'emploi

Pour préserver les hautes performances et la fiabilité de cet appareil, éviter de l'utiliser ou de l'entreposer dans les endroits suivants:

Precauciones al usaria

Para conservar el alto rendimiento y la confiabilidad de esta unidad, evite usarla o guardarla en las condiciones siguientes.



- Dusty places.
- In high humidity areas such as the bathroom.
- Emplacements poussiéreux.
- Dans une pièce très humide, telle qu'une salle de bain.
- Sitios polvorosos.
- EN sitios de mucha humedad, tal como el baño.

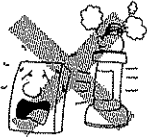

- Near heat sources such as stoves, etc.
- Près de sources de chaleur comme un radiateur, etc.
- Cerca de fuentes de calor como por ejemplo estufas, etc.

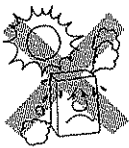

- Places exposed to direct sunlight, especially in a closed car.
- Endroits exposés directement au soleil, en particulier dans une voiture fermée.
- Lugares expuestos a los rayos directos del sol, especialmente en el interior de automóviles cerrados.

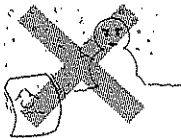

- Extremely cold places.
- Endroits extrêmement froids.
- Lugares extremadamente fríos.

g. 2

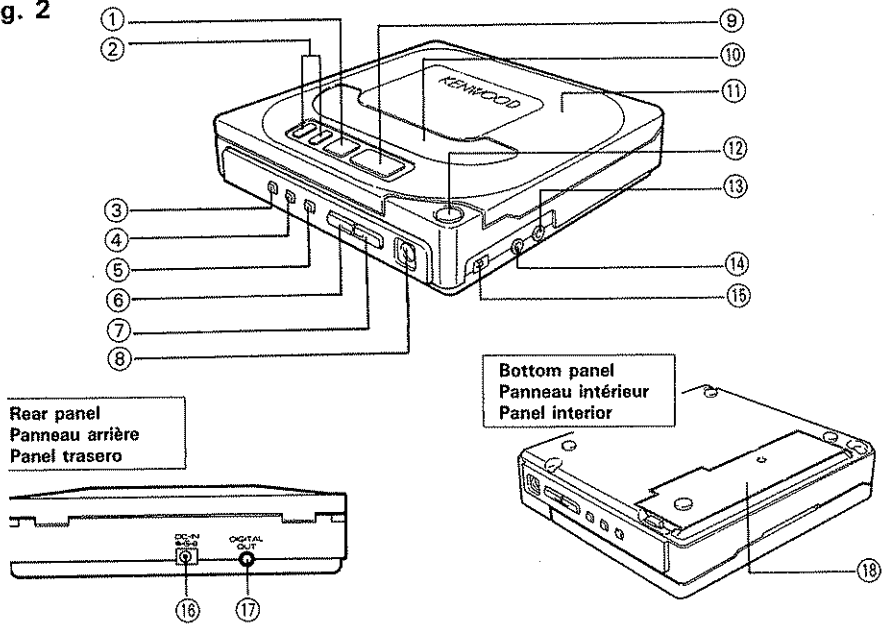

Rear panel
Panneau arrière
Panel trasero

Bottom panel
Panneau intérieur
Panel interior

g. 3

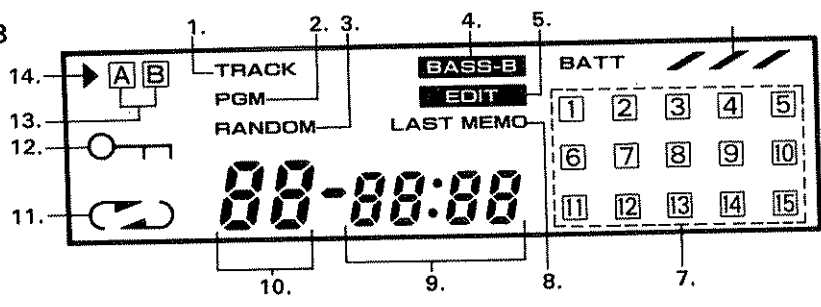

g. 4

Rear panel
Panneau arrière
Panel trasero

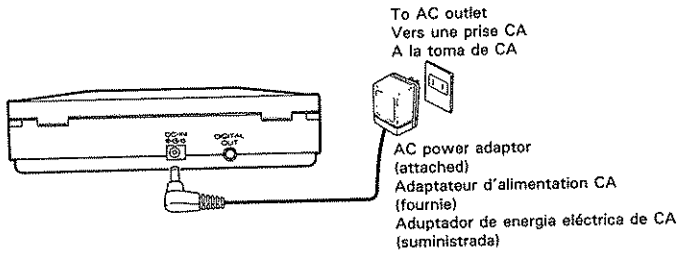

To AC outlet
Vers une prise CA
A la toma de CA

Fig. 5

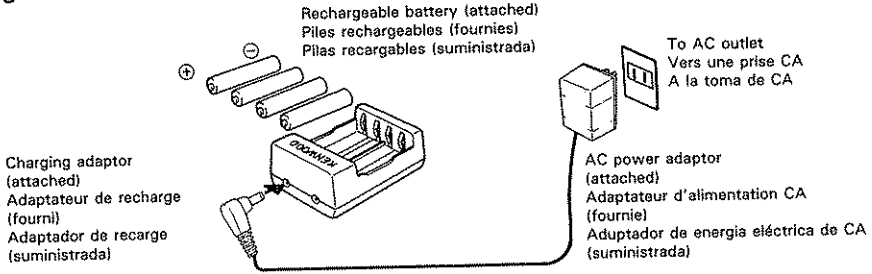

Fig. 6

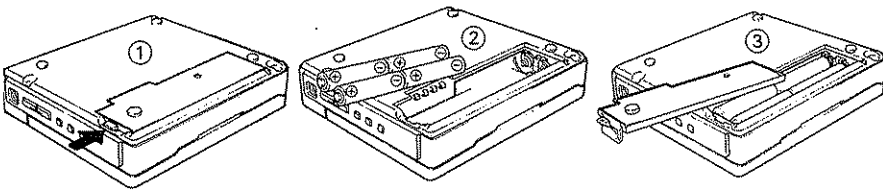

Fig. 7

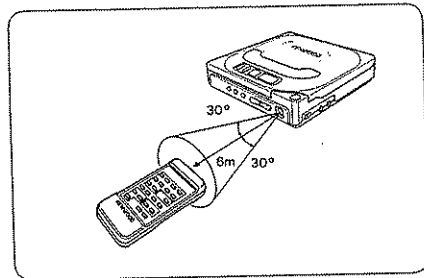
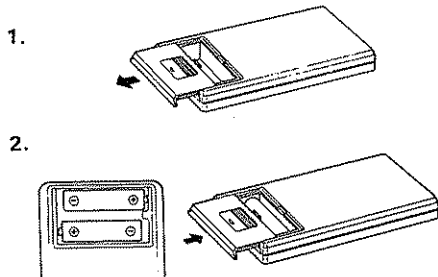
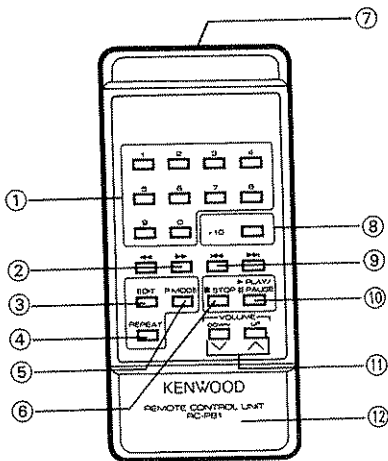

Fig. 8

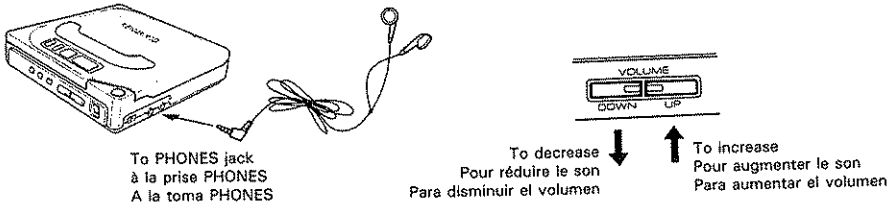
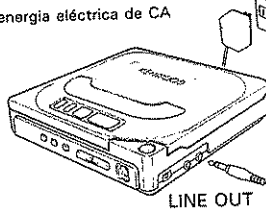
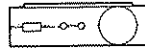

Fig. 9

AC power adaptor
(attached)
Adaptateur d'alimentation CA
(fournie)
Adaptador de energía eléctrica de CA
(suministrada)



Amplifier
Amplificateur
Amplificador



Tape deck
Magnétophone
Magnetófono

Radio cassette
recorder, etc.
Radio-magnéto
cassette etc.
Radiocassetts, etc.

- Never connect the plug to the "DIGITAL OUT" jack.
- Ne jamais connecter la prise à la prise "DIGITAL OUT".
- No conectar nunca el enchufe en la toma "DIGITAL OUT".

Fig. 11

Right side panel
Panneau latéral
droit
Panel lateral
derecho

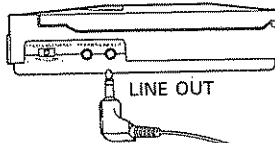

Car audio system
Chaîne autoradio
Sistema de audio de automóvil



- Never connect the plug to the "DIGITAL OUT" jack.
- Ne jamais connecter la prise à la prise "DIGITAL OUT".
- No conectar nunca el enchufe en la toma "DIGITAL OUT".

Fig. 12

Air blower
Poire soufflante
Soplador de aire

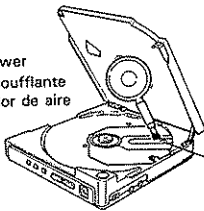

Lens
Lentille
Lente



Unpacking

Unpack the unit carefully and make sure that all accessories and cables are put aside so they will not be lost.

Examine the unit for any possibility of shipping damage. If your unit is damaged or fails to operate, notify your dealer immediately. If your unit was shipped to you directly, notify the shipping company without delay. Only the consignee (the person or company receiving the unit) can file a claim against the carrier for shipping damage.

We recommend that you retain the original carton and packing materials for use should you transport or ship the unit in the future.

Before applying power of AC adaptor

Important!

USA and Canada

Unit shipped to the above are not equipped with an AC voltage selector switch and the discussion of such a switch that follows should be disregarded.

All other countries

AC adaptor shipped to countries other than the above are equipped with an AC voltage selector switch on the top cover. Refer to the following paragraph for the proper setting of this switch.

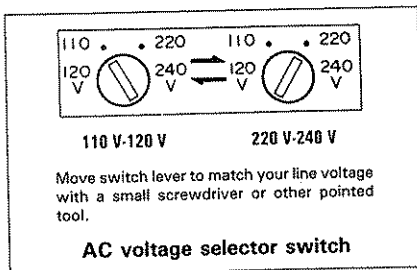

Fig. 1

Before plugging in this unit, make sure that the position of the AC Voltage Selector conforms to your line (mains) voltage. If not, it must be reset. See Fig. 1.

AC voltage selection

AC adaptor operates on 110~120 volts or 220~240 volts AC. Before connecting the power cord to your AC outlet, make sure that the setting position of this switch matches your line voltage. If not, it must be set to your voltage in accordance with the following direction.

Note:

Our warranty does not cover damage caused by excessive line voltage due to improper setting of the AC voltage selector switch.

WARNING:

TO PREVENT FIRE OR ELECTRIC SHOCK, DO NOT EXPOSE THIS APPLIANCE TO RAIN OR MOISTURE.

WARNING NOTICE:

IN MOST CASES IT IS AN INFRINGEMENT OF COPYRIGHT TO MAKE COPIES OF TAPES OR DISCS WITHOUT THE PERMISSION OF THE COPYRIGHT OWNERS. ANYONE WISHING TO COPY COMMERCIALY AVAILABLE TAPES OR DISCS SHOULD CONTACT THE MECHANICAL COPYRIGHT PROTECTION SOCIETY LIMITED OR THE PERFORMING RIGHTS SOCIETY LIMITED.

Controls, connectors and indicators <Fig. 2>

- | | |
|---|-----------------------------------|
| ① [■] STOP/OFF button (POWER OFF) * | ⑩ Display |
| ② [◀▶▶▶] SKIP/SEARCH button | ⑪ Lid |
| ③ DISPLAY button | ⑫ OPEN button |
| ④ P.MODE (Program mode) button | ⑬ LINE OUT jack |
| ⑤ BASS-BOOST switch | ⑭ PHONES jack |
| ⑥ VOLUME DOWN button | ⑮ HOLD/LAST MEMO. (memory) switch |
| ⑦ VOLUME UP button | ⑯ DC IN jack (3 ~ 5 V) |
| ⑧ Remote control receptor | ⑰ DIGITAL OUT jack |
| ⑨ PLAY/PAUSE [▶/] button (POWER ON) * | ⑱ Battery cover |
- * While the AC adaptor or car adaptor is being used, the lamp on the [▶/||] and [■] button is lit up for easy recognition.

ENGLISH

Display description <Fig. 3>

- This is indicated when the data of disk is scanned.
- This is indicated when the Program Input Mode or EDIT mode is set.
- This is indicated when the Random Play operation is set.
- This is indicated while [BASS-BOOST] is being ON.
- This is indicated while [EDIT] is being set ON.
- This indicates the consumption of the rechargeable batteries with three bars.
- This indicates the track number memorized into the disk, programmed track number, etc. 15 musics are indicated at maximum.
- This is indicated while [LAST MEMO.] is being set ON.
- This indicates the total recording time and total elapsed time of the disk, and the elapsed time of a music being played.
- This indicates the total number of musics and the order of musics in the disk which is being played and programmed.
 - This is indicated while Repeat Play is being operated.
 - This is indicated while [HOLD] is being set at ON.
 - This is indicated either Side A or B of the tape while [EDIT] is set.
 - During the Play or Search operation, this is indicated during the Pause operation, this is blinked.

Power source

I Use in the following method:

Rechargeable Battery (Attached)	Use after recharging with the attached recharging adaptor.
Alkali Battery	Use size AA alkali manganese dry batteries which are available in the general market.
Household AC Power Source	Use the attached AC adaptor.
Car Battery	Use the optional car-battery adaptor DC-C4 (exclusive for 12-V car). (When a car-battery adaptor other than DC-C4 is used, the manufacturer cannot guarantee any resultant effects.)

I How to use the main unit with the attached AC adaptor <Fig. 4>

- When this attached AC adaptor is used, the power source can be supplied from household outlets. Insert the plug of the AC adaptor into the power-source terminal on the reverse side of the main unit, then connect the AC power adaptor to a household outlet.
- Pull out the AC adaptor from the outlet when it is not in use. Conduct insertion into or pulling out from the power source terminal after pressing the "STOP/OFF" button twice in order to turn the main unit into "POWER OFF" condition.

■ How to Use the Unit with the Attached Rechargeable Batteries <Fig. 5>

The usable batteries are only the attached rechargeable batteries (KN-3U). Generally marketed rechargeable batteries and manganese dry batteries cannot be used.

Charge the attached rechargeable batteries for eight hours, if you use them for the first time.

● How to Recharge

1. Insert the attached rechargeable batteries into the attached recharging adaptor with correct polarity.
2. Connect the attached AC adaptor to a household outlet, then insert the output jack of AC adaptor into the power source terminal in the 4 V side of the charging adaptor to activate recharging.

● How to Recognize the Timing of Recharging

If one of the three bars for the indication of remaining battery life on the indicator of the unit starts blinking, battery life is running out. Recharging is necessary. If the play is activated when the batteries are running out, three bars of battery-life indicator are lit up then whole indication will be put out.

● How to Recognize the Recharging Time

In the normal use, 5 hours of recharging allows continuous play for about 1.5 hours.

Recharge them for about 8 hours, however, if they are not used for a long period of time.

● How to make batteries stand up to long use

If recharge is repeated for the attached batteries, where as the power of batteries is still remained, the batteries may not be recharged enough as their property. In such a case, use up the power of them before conducting recharging, which allows them for normal recharging.

Cautions:

- Be sure to use only the attached AC adaptor for recharging. It is dangerous if you use other kind of AC adaptor.
 - Avoid adverse recharging and short circuit. They result in causing of such troubles as deterioration of rechargeable batteries and generation of heat.
 - Do not disassemble and modify it by yourself.
 - After completion of recharging, remove batteries from the recharging adaptor, then pull out the AC adaptor from the outlet.
 - Do not touch the CD player, AC adaptor and recharging adaptor with wet hands.
 - For recharging, use only the attached recharging adaptor which is exclusive for this unit.
 - Should the liquid contained in the battery attach on your skin or clothes due to breakage, etc. rinse it off with much running water.
 - Avoid overcharging a battery for 24 hours or more. It shortens the battery life.
-

How to Insert the Batteries into the Battery Compartment <Fig. 6>

Open the battery cover.

- ① Lift the cover while pressing the STOP button.

Insert the batteries.

- ② Insert the four attached rechargeable batteries or alkali manganese batteries into the battery compartment surely by paying attention for correct polarity.

Close the battery cover.

- ③ Fit the hook of battery cover into the specified position.
- ④ Be sure to fit it into the specified position until it clicks and gets locked.

Service Life of Rechargeable Battery:

Rechargeable battery has a life.

After about 500 times of recharging, its performance (operating time) is halved as compared to a new battery. If operating time shortens considerably although you have charged your battery properly, purchase four rechargeable batteries for replacement.

ENGLISH

Wireless Remote Control Unit <Fig. 7>

The function of each switch is the same as that of the switches on the main unit.
POWER ON operation is not possible with the remote controller.

- ① Direct Music Selection button (0 - 9) (Remote Control only)
- ② Manual Search button [◀◀ ▶▶] (independent for Remote Control)
- ③ EDIT button (Remote Control only)
- ④ REPEAT button (Remote Control only)
- ⑤ P.MODE (Program mode) button
- ⑥ STOP button [■]
- ⑦ Remote-Control Signal Sender
- ⑧ Direct Music Selection button (+ 10) (Remote Control only)
- ⑨ Skip button [◀◀ ▶▶] (independent for Remote Control)
- ⑩ PLAY/PAUSE button [▶/II]
- ⑪ VOLUME DOWN/UP button [∨ / ^]
- ⑫ Battery Compartment (Reverse Side)

■ How to Insert Batteries into the Battery Compartment

1. Slide the cover on the reverse side of the battery compartment to the direction of the arrow by applying slight pressure onto it.
2. Insert the two attached size-AAA dry batteries into the battery compartment. Place the batteries into the specified position correctly in accordance with the indication of polarity shown at the bottom of the battery compartment.

Note:

- The attached dry batteries are used to check actions of the Remote Controller. Note that their life may be short. When the remote-controllable range gets narrower or the remote controller stops working, replace both batteries with new ones.

■ Operating Range of Remote Controller

It varies with the such conditions as temperature, humidity, place to be used and so on. However, it is basically as shown in the following illustration. If there is any obstruction between the main unit and remote controller, it does not work correctly.

Notes:

- When you press next operation key after pressing an operation key on the remote controller, pause for a second or more, then press it surely and steadily. If you press next operation key immediately after pressing an operation key, it may not work correctly.
- It may not work well at the place where it is exposed to direct sunlight.

Listening through headphones < Fig. 8 >

- Connect the optional headphone plug with the "PHONES" jack (use ϕ 3.5 stereo mini plug).
- Conduct the pull-in/out operation of the jack during Power is OFF.
- Adjust the volume with the VOLUME button.

As a Compact Disc contains very little noise, a sudden loud sound could be output if the VOLUME control is adjusted too high: this could cause serious damage to your ears.

Playback through a home audio system

■ Playback using the "LINE OUT" output < Fig. 9 >

- Power is supplied through the provided AC adaptor.
- Connect the attached audio connection cord to "LINE OUT" of the main unit, then insert the white plug into the outside-input terminal (AUX terminal) of amplifier or the left input terminal of CD input terminals. Set the input selector of amplifier to "AUX" or "CD". When input is to be made from the main unit to a tape deck, connect the cord to "LINE-IN" terminal.
- Adjust the volume between the amplifiers.
- When the direct input from the main unit to a tape deck is to be made, adjust the volume with volume-level adjuster (REC LEVEL) of the tape deck. In this case, be sure to confirm the volume through a headphone connected to the tape deck and the peak level indicator of the tape deck. (Usually, connect the main unit to the CD terminal or AUX terminal of the amplifier, and connect the tape deck to the tape input/output terminal of the amplifier.)

Caution:

Before making connections, be sure to turn the amplifier power off.

Do not connect the main unit to the PHONO terminal of the amplifier.

■ Playback using the "DIGITAL OUT" output < Fig. 10 >

- Power is supplied through the provided AC adaptor.
- The output from "DIGITAL OUT" can be connected to the digital input of other audio equipment, such as a digital amplifier, to obtain higher sound quality.

Notes:

- Before making connections, be sure to turn the amplifier power off.
- If the CD player interferes with radio or TV reception. Place the CD player away from the radio or TV, or disconnect the power to the CD player.
- **Never connect the output from the "DIGITAL OUT" jack to the analog input jack of an amplifier, as this will cause damage to the amplifier or speakers.**
- The VOLUME buttons (on the main unit or remote control unit) are disabled. Adjust the volume on the amplifier.

Fig. 10

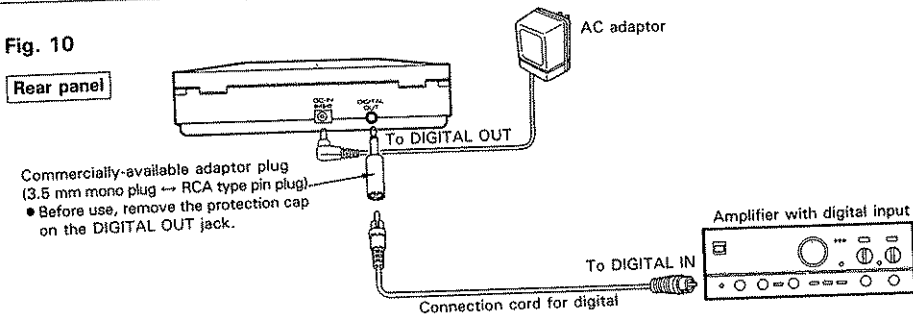

CD playback in an automobile <Fig. 11>

- When the power source is taken from a cigar socket of a car, use the optional car battery adaptor DC-C4. It allows you to enjoy listening to music for a long time without worrying about the battery consumption.
- Insert the plug of car audio cassette adaptor CAC-1 into the "LINE OUT" terminal of the main unit. Insert the CAC-1 to the car component deck, and turn the car component deck into the play mode.
- Adjust the volume on the car audio side.

Notes:

- In case the unit is used in a car, install it taking the safety in consideration, so that it does not interfere with the driving operations.
- The CAC-1 cannot be used with some car audio cassette models.
- Do not leave the unit and Remote Controller in a closed automobile where the temperature is expected to be high.
- Place the unit on a soft place where automobile vibrations are not easily transmitted.
- If any sound skipping occurs due to vibrations, turn on the [HOLD] switch to reduce the sound skipping.

8 cm CD single can also be played

This unit can play 8 cm CD singles directly without using an adaptor.

Caution:

- Do not use an adaptor sold for other models (otherwise the CD or this unit may be damaged).

How to Play (Manual Play)

■ Types of Play

Manual Play	Plays musics from the first track to the last track (Basic Operation). (See Page 11.)
Repeat Play/Random Play	Plays your favorite music repeatedly. (See Page 13.)
Direct Play	Picks up your favorite music. (See Page 14.)
Program Play	Reserve your favorite musics by order as you like. (See Page 15.)

■ Manual Play (Basic Operation)

Leave the HOLD switch turned OFF.

- 1 Push the OPEN button.
- 2 Open the lid: Lightly lift the lid near the OPEN button.
- 3 Insert the disk: Be sure to keep the label side of the disk upward.
- 4 Close the lid.
- 5 Push the PLAY/PAUSE [▶/||] button:

The unit starts playing automatically after scanning the data of the disk.

When PLAY/PAUSE [▶/||] button is pressed to POWER ON.

When the unit scans the data of disk and starts playing automatically.

In the event that data is not read or a disc is not inserted. (It will turn out to be POWER OFF after elapsing of three minutes.)

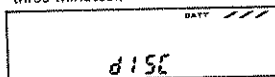
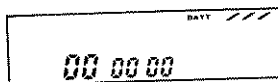

- 6 Adjust the volume.

During Power is ON, -20 dB (1/10 of maximum volume) is set.

■ **To operate temporary stop (pause)**

⑦ **Push PLAY/PAUSE [▶/||] button:**

If you press it once more, the unit starts playing from the paused position.

■ **To stop**

⑧ **Push the STOP/OFF [■] button twice:**

If the STOP/OFF button is pressed once, the unit is put in the standby mode. If it is pressed once again, the unit is turned out to be POWER OFF.

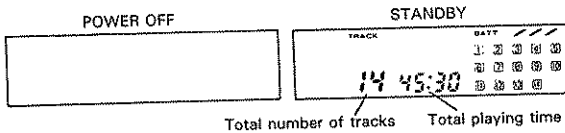

● If the standby mode lasts for 3 minutes or more, the unit is turned out to be POWER OFF.

⑨ **Indication of Time:**

● Whenever the DISPLAY button is pressed, the following indications are shown.

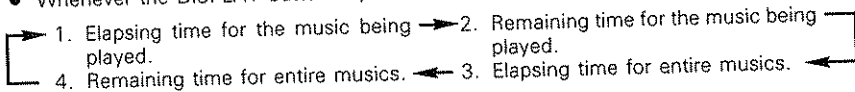

● During the play mode, elapsed time of the music being played is indicated.

Notes:

- If OPEN button is pressed, all the contents is erased and the unit is turned out to be POWER OFF.
- If the lid is open, all the functions do not work. Closing the lid does not simply allow the unit to turn out to be POWER ON.
- If the PLAY/PAUSE [▶/||] button is pressed during the standby mode, the unit starts playing from the first track.
- When the music is played until the final track and the player has naturally entered the standby mode, it indicates the total playing time.
- Be sure not insert the disk up side down. If the disk is inserted into the unit with reverse side up, the unit can not start playing.
- Do not insert anything other than the disk into the disk tray.
- A disk may be damaged if it is inserted diagonally into the disk tray.
- If the HOLD switch is being turned ON, PLAY/PAUSE [▶/||] operation cannot be activated even the button is pressed.

■ **To skip to the beginning of desired track (Skip feature, ◀◀, ▶▶), to search in the forward or backward direction (Search feature, ◀◀, ▶▶)**

- The skip function is activated with one press of button and the search function is activated with continuous press of button.
- Operate during play (Basic Operations (5), (6)), or standby mode (Basic Operation (8)).

⑩ **To skip to the beginning of the track being played:**

Tap the ◀◀ button for an instant.

To skip to the beginning of the next track:

Tap the ▶▶ button for an instant.

- When you wish to skip back to the previous music, press the ◀◀ button once more.
- The first music is caused to play if ▶▶ button is pressed while the last music is being played.
- If you press ◀◀ button during the standby mode, the last music is activated to play.

The above-mentioned operations are common to both the main unit and remote controller.

⑪ **How to operate the quick return with the main unit:**

Push ◀◀ button continuously.

How to operate the quick traverse:

Push ▶▶ button continuously.

⑫ **How to operate the quick return with the remote controller:**

Push ◀◀ button continuously.

How to operate the quick traverse:

Push ▶▶ button continuously.

- If you release the quick return and quick traverse buttons, the unit plays the music from that position.
- If an operation is made during the pause mode, the music is paused at the position where the button is released.

The above-mentioned operations are common to both the main unit and remote controller.

How to Play (Repeat Play/Random Play)

■ **Repeat Play/Random Play (Basic Operations (1) - (6) are omitted.)**

- This function can be operated only by the remote controller.
- Operate during the play or standby mode (Basic Operation (8)).

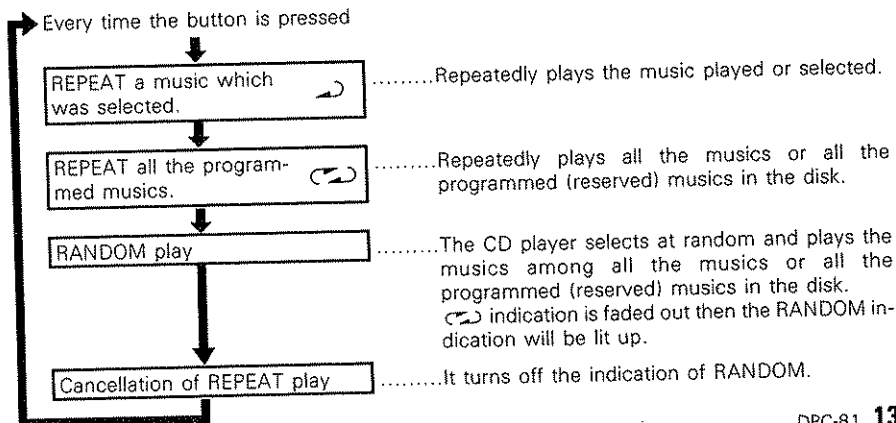

13 How to repeatedly play the music being played or selected:

Push the REPEAT button once.

14 How to repeatedly play all the music or all the programmed musics in the disc:

Push REPEAT button twice.

15 How to select at random and play the musics from all the musics or all the programmed musics in the disc:

Push REPEAT button three times.

Example: When the disc or program contains 7 tracks

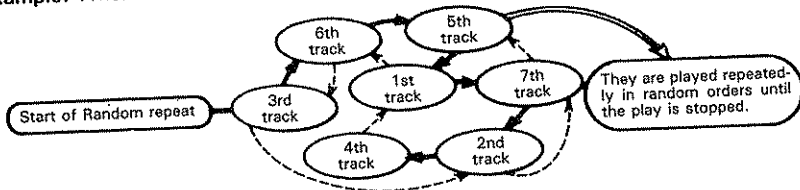

- The random play operation is repeated endlessly unless the STOP button is pressed, or the REPEAT mode is canceled.

Notes:

- If the mode is changed to the random mode during the standby mode and the PLAY/PAUSE (▶/||) button is pressed, the random search mode is activated.
- If the mode is changed to the random mode during the playing operation, the mode is changed to the random search mode after the music being played is over.
- If the ▶▶ button is pressed during the random play, the mode is changed to the random search mode.
- If the ◀◀ button is pressed during the random play, the music being played is replayed.
- During the random play, 0-9 and +10 buttons cannot be operated.

How to Play (Direct Play)

■ Direct Play (Basic Operations ① - ⑥ are omitted.)

- This function can be operated only by the remote controller.
- By just pressing the direct music selection button, the selected music is played immediately.
- Operation can be performed during the play or standby mode (when the unit is stopped with a disc inserted).
- If the number larger than the number of musics in the disk is selected, it is not accepted.

16 In case of selecting either one of Musics 1 through 9:

Push either of Buttons 1 through 9.

In case of selecting either one of Musics 10 through 19:

Push either one of Buttons 0 through 9 after pressing the +10 Button.

In case of selecting either one of Musics 20 and beyond:

Push either one of Buttons 0 through 9 after pressing the +10 Button twice.

In case of selecting either one of Musics 30 and beyond:

Push either one of Buttons 0 through 9 after pressing the +10 Button three times.

How to Play (Program Play)

- Operate during the standby mode. It cannot be operated if the mode is in other than the standby mode.
- 24 favorite musics can be programmed (reserved) in the order you like to listen to.
- After completion of the programming (reservation), play is activated if "PLAY/PAUSE [▶/||]" (on the main unit or remote controller) is pressed.

■ How to Program with Direct Music Selection

(Basic Operations ① - ⑥ are omitted.)

⑰ Push P. MODE button:

- It enters the program input mode.

⑱ Select the music:

(Select the music with the direct music selection button on the remote controller. Follow the procedures in ⑯.)

Reservation is completed by selecting the music.

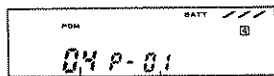

Track programmed Memory No.

- Completion of reservation of Music 1 (P-01).

⑲ Select the music (from Musics 2, 3, ... 24):

- Repeat the operation in ⑱. By repeating music selection, the reservation can be made one after another.

⑳ Push PLAY/PAUSE [▶/||] button: Stars to play.

- Operate with the LAST MEMO. switch in the OFF condition.

■ How to program with the SKIP button

(Basic Operations ① - ⑥ are omitted.)

㉑ Push P. MODE button:

- Enters the program input mode (the same operation as in ⑱).
- Also operate with the P.MODE button on the remote controller.

㉒ Select with the SKIP/SEARCH [◀▶] button (Music 1):

(On the remote controller, select with the SKIP [◀▶] button.)

- The same operation as in ⑩ and ⑪.

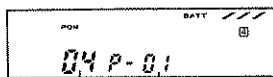

Track programmed Memory No.

㉓ Push the P. MODE button.

㉔ Select the music (from Musics 2, 3, ... 24):

- Repeat the operation in ㉒ and ㉓.

■ Confirmation of the Programmed Contents

- This function can be operated when the disc is programmed and stopped.

25 Push P. MODE button:

- Indicates the music number of Music 1.

26 If the P. MODE button is pressed repeatedly:

- Then the programmed contents are indicated in order.
- If the music orders are indicated until the last programmed music, the indication returns to Music 1.

■ How to Change the Contents of the Program

27 Call the program number to be changed by pressing the P. MODE button:

Example:

When you wish to change the music in Track 6 of the Program Number 3 to Track 7, call the Program Number 3 by pressing the P. MODE button.

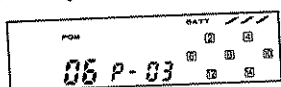

If the Button 7 on remote controller is pressed, Track 6 is revised to Track 7.

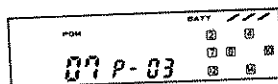

- You can also revise the track after indicating the Track 7 with \lll and \ggg buttons on the main unit, and then pressing the P. MODE button.

■ How to Cancel All the Programs

28 Put the unit to POWER OFF or open the lid:

- Push the STOP/OFF button once when the musics are is programmed and the disc is stopped in order to enter the unit into the standby mode, or press the STOP/OFF button twice during play in order to put the unit to POWER OFF.
- Push the OPEN button.

■ Other Functions

- During the programmed play, the unit is in the auto space mode. Then, the four-second pause is inserted between the musics.
- If the SKIP button is pressed during the programmed play, skip search can be made only with the programmed track.
- When the program is called during the program standby mode and the PLAY/PAUSE $\blacktriangleright/\parallel$ button is pressed with LAST MEMO. OFF (See Page 19), the player will play from the first music programmed, not the music whose number is indicated now.
- The random operation during the program play searches the programmed track numbers at random.
- The Buttons 0 ~ 9 and +10 can not be operated during the programmed play.

EDIT Function

EDIT function is the function to edit by fully making use of the recordable time of a tape when a CD is dubbed into a tape.

- In the stand-by mode, you can select EDIT 1, EDIT 2 and EDIT 3 modes by pressing the EDIT button (only remote controller) once, twice and three times respectively.

■ EDIT 1 (Time Edit) Mode

- This is the mode to edit in accordance with the length of a tape.

29 Press the EDIT button once:

- In the program standby mode, this operation can not be made.

30 Input the accommodating time of a tape with the direct music selection buttons (0 ~ 9) and (+ 10):

Example: In case of a 54-minute long tape:

- ① Press the +10 button for 5 times and the 4 button for once in order to input the length of time of a tape.



- ② In 2 seconds, the programs on Side A and remaining time of the tape is indicated.



- ③ In 4 seconds, the programs on Side B and remaining time of the tape is indicated.

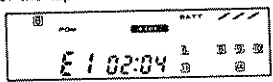

- ④ In 4 seconds, pause is activated at the first music of Side A.



- Arrange the musics from the initial music of a CD in order so as to accommodate them within the designated accommodating time of Side A of a cassette tape, and select the most suitable music within its remaining time for the last music.
- Arrange the musics in order for Side B excluding the musics programmed into Side A, and select the most suitable music for the last music on Side B.
- When all the musics are recorded into Side A, "no-FILE" is indicated on the display and pause is activated at the first music on Side A.
- After Side A is completed, pause will be activated at the beginning part of Side B.
- When the playing operation is completed up to the end of Side B, the normal standby mode is automatically activated.

■ EDIT 2 (Program Edit) Mode

- This is the mode to edit by selecting your favorite musics.

31 Press the EDIT button twice.

32 Select the musics which you wish to listen to with the direct music-selection button (0 ~ 9) (+ 10):

Example: The first music:

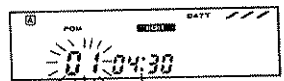

The indication of the first music is blinking.

The time-elapsing indication of the first music.

33 Press the P.MODE Button:

- Accumulated time will be indicated.
- Input the musics you wish by suiting the accumulated time to the tape and repeating the procedures of 32 and 33.

34 Press the EDIT Button after Side A is Completed in Order to Make an Input into Side B.

- If the EDIT button is pressed once again after Side B is completed, pause will be activated at the first music of Side A.

Notes:

- When Side A is completed, pause is activated at the initial section of Side B.
- When Side B is completed, the normal standby mode is activated.

EDIT 3 (Time Fade Edit) Mode

- This is the editing mode on the basis of fade-in and fade-out operations.
- It is only output from the PHONES jack. (It does not work on the LINE OUT)

35 Press the EDIT Button three times.

36 Input the Accommodating Time of the Tape with the Direct Music Selection Buttons (0~9) and (+ 10):

Example: In case of 60-minute long tape:

- ① Press the +10 button for 6 times and the 0 button once in order to input the length of time of a tape.

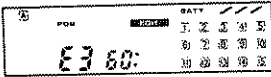

- ② The fade-out time of Side A is indicated two seconds later.



- ③ In 4 seconds, Side B is indicated.



- ④ In 4 seconds, pause is activated.



37 Press PLAY/PAUSE [▶/||] Button.

- The fade-out operation starts 4 seconds before the set time.

Notes:

- When Side A is completed, pause is activated at the fade-out starting position on Side A, and then Side B is indicated.
- When Side B is completed, normal standby mode is activated.
- On Side B, fade-in operation starts from the fade-out position of Side A.

Convenient Functions

Prevention of Misoperation [HOLD]/Reduction of Sound Skip [Anti shock]/Last Memory Function

- This unit has the HOLD function to prevent misoperation, the anti shock function to reduce the sound skipping and the LAST MEMO. function to memorize the musics until the power is turned off. When the unit is used in the car or elsewhere where there is big vibrations, the sound skipping is reduced.

Turn on the HOLD switch:

- If the "HOLD" is turned on in the POWER OFF mode, the unit will not be turned to the POWER ON mode even though the PLAY/PAUSE [▶/||] button is pressed.
- The PLAY operation only is accepted during the standby mode.
- If the "HOLD" is turned ON during the play, the button switches other than the "OPEN" button can not be operated.
- Operation from the remote controller can be performed even during the HOLD mode.

When the LAST MEMO. switch is turned on, the following operations are made:

- When the power is turned on from the off condition, the player starts to play the music from the beginning part of the music where the present location of the pick-up is read.
- If the STOP/OFF button is pressed and the PLAY/PAUSE [▶/||] button is pressed again, the player starts to play from the beginning part of the stopped music. (When it is paused at the near end of a music, it may start playing from the beginning part of the following music.)
- If the SKIP button [◀◀] is pressed during the standby mode, the player starts to play the music previous to the music for which the STOP/OFF button is pressed.
- If the SKIP button [▶▶] is pressed during the standby mode, the player starts to play the music next to the music for which the STOP/OFF button is pressed.

■ Battery Life Indicator

- The battery life indication is indicated with three bars, assuming the attached rechargeable batteries are used as the standard. (Correct indication is not brought about if batteries other than the attached batteries are installed.)
- If the batteries are charged fully, three bars are indicated. Two bars are indicated if the batteries are charged normally. When one bar is indicated, the indication changes from lighting to blinking. In such a case, recharge the batteries immediately.

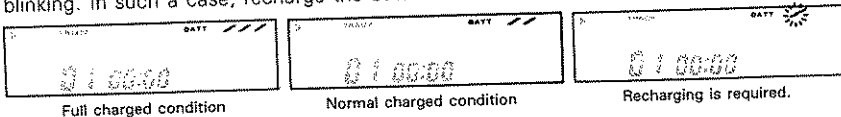

■ BASS-BOOST Function

When the-BASS BOOST switch is turned ON:

- You can enjoy listening to the music with dynamic bass sound with boosted ultra bass sound when you listen to the music thorough head phones.
- The BASS BOOST function does not work against the signals which are output from the LINE OUT jack.

Simple care and maintenance <Fig. 12>

■ When you clean the cabinet

As this unit is specially painted, do not rub it hard with hard cloths and so on. Wipe off the dirt on the cabinet with a soft cloth. If the stain is so bad that it cannot be removed with a soft cloth, moisten the cloth with a small amount of water. Then, wipe it with this moistened cloth. Be sure to wipe it again with a dry cloth to remove the moisture.

■ Cleaning the lens

Clean the lens carefully, using a commercially-available camera lens blower, etc.

■ Care and maintenance of discs

If dirt or dust is attached to the playing surface of a disc, clean it carefully using a commercially-available CD cleaning cloth, etc.

When wiping the disc, be sure to wipe it in a radial direction, as shown in the Fig. 12. (Do not use a record cleaner for ordinary disks.)

Avoid leaving discs under direct sunlight or in a place where the temperature is high.

When a disc is not to be used for a long period of time, do not leave it in the CD player.

Specifications

Tracking system	Three-beam tracking	
Laser type	Semiconductor laser	
D/A converter	16 bit, linear	
Filter	8 times oversampling digital filter	
Frequency response	20 to 20,000 Hz, ± 1 dB	
Total harmonic distortion	0.04% (at 1 kHz)	
S/N ratio	90 dB, 1 kHz	
Channel separation	80 dB, 1 kHz	
Wow & flutter	Below measurable limit	
Output terminals	Headphone jack: 3.5 mm stereo mini-jack LINE OUT jack: 3.5 mm stereo mini-jack DIGITAL OUT jack: 3.5 mm mono mini-jack DC IN 3 V to 5 V (external power supply)	
Input terminal		
Output level	15 mW + 15 mW (16 Ω , at 1 kHz)	
Line output	0.8 V (47 k Ω at 1 kHz)	
Power consumption	0.9 W	
Power requirement	3 V DC: provided rechargeable batteries or external DC IN jack 120 V AC, 60 Hz (USA and Canada type, using the provided AC adaptor) 220-240 V AC, 50 Hz (U.K., Europe, and Australia, using the provided AC adaptor) or 110-120/220-240 V AC, 50/60 Hz (All other type, using the provided AC adaptor)	
Battery life	About 1.5 hours (continuous Repeat Play) (may vary depend on charging condition)	
Dimensions (W x H x D)	130 x 34 x 137 mm	
Weight	490 g (without rechargeable battery)	
Accessories	Audio connection cord	x 1
	AC adaptor	x 1
	Charging adaptor	x 1
	Wireless remote control unit (RC-P81)	x 1
	Car audio cassette adaptor (CAC-1)	x 1
	Dry battery (AAA)	x 2
	Rechargeable battery (AA)	x 4

KENWOOD follows a policy of continuous advancements in development. For this reason specification may be changed without notice.

Avant de brancher l'adaptateur CA

Important!

Etats-Unis, Canada, Royaume-Uni, Europe et Australie

Les appareils livrés dans les pays ci-dessus ne sont pas munis d'un sélecteur de tension CA et les descriptions du sélecteur qui suivent doivent être ignorées.

Tous les autres pays

L'adaptateur CA livré dans les pays autres que ceux cités ci-dessus est muni d'un sélecteur de tension CA sur le dessus. Se référer au paragraphe suivant pour un réglage correct de ce sélecteur.

Sélection de tension CA

L'adaptateur CA fonctionne sur 110~120 volts ou 220~240 volts CA. Avant de brancher le cordon d'alimentation sur votre prise CA, s'assurer que la position de ce commutateur convient à votre tension de ligne. Dans le cas contraire, il doit être réglé selon les instructions suivantes.

Remarque:

Notre garantie ne couvre pas les endommagements provoqués par une tension de ligne excessive due à un mauvais réglage du sélecteur de tension CA.

ATTENTION:

POUR EVITER TOUT RISQUE D'INCENDIE OU DE CHOC ELECTRIQUE, PLACER CET APPAREIL A L'ABRI DE LA PLUIE ET DE L'HUMIDITE.

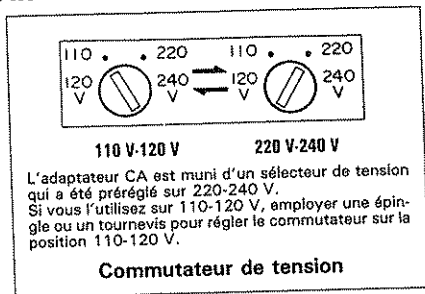

Fig. 1

Avant de brancher cet appareil, s'assurer que la position du sélecteur de tension CA convient à votre tension de ligne (secteur). Dans le cas contraire, il faut le régler. Voir la Fig. 1

AVERTISSEMENT:

DANS LA MAJORITE DES CAS, C'EST UNE INFRACTION A LA LOI SUR LES COPYRIGHTS D'EFFECTUER DES COPIES DE BANDES OU DE DISQUES SANS LA PERMISSION DES DETENEURS DES DROITS D'AUTEUR. TOUTE PERSONNE DESIREUSE DE COPIER DES BANDES OU DISQUES EN VENTE DANS LE COMMERCE DOIT CONTACTER LA SOCIETE LIMITEE DE PROTECTION DES COPYRIGHTS MECANIQUE OU LA SOCIETE LIMITEE DES DROITS D'EXECUTION.

FRANCAIS

Commandes, connecteurs et indicateurs <Fig. 2>

- ① [■] Touche et annulation d'arrêt/arrêt (STOP/OFF) (POWER OFF) *
- ② [◀▶] Touche Saut/Recherche (SKIP/SEARCH)
- ③ Touche affichage (DISPLAY)
- ④ Touche de mode programmation (P.MODE)
- ⑤ Commutateur amp-basses (BASS-BOOST)
- ⑥ Touche VOLUME DOWN (Volume -)
- ⑦ Touche VOLUME UP (Volume +)
- ⑧ Detecteur de télécommande à infra-rouge
- ⑨ [▶||] Touche de lecture/pause (PLAY/PAUSE) (POWER ON) *
- ⑩ Affichage
- ⑪ Couvercle
- ⑫ Touche d'ouverture (OPEN)
- ⑬ Prise de sortie de ligne (LINE OUT)
- ⑭ Prise de casque (PHONES)
- ⑮ Commutateur maintien/dernier memoire (HOLD/LAST MEMO.)
- ⑯ Prise d'entree de courant continu (DC IN, 3 - 5 V)
- ⑰ Prise de sortie numérique (DIGITAL OUT)
- ⑱ Couverde de batterie

* Si un adaptateur ca ou un adaptateur d'automobile est utilisé, le témoin de la touche [▶||] et [■] s'allume pour l'indiquer.

Description de l'affichage <Fig. 3>

1. Le disque est en cours de balayage.
2. Le lecteur est réglé sur mode programmation ou sur mode d'édition.
3. Le lecteur est réglé sur Lecture au hasard.
4. Le lecteur est réglé sur [BASS-BOOST].
5. La touche [EDIT] est réglé sur ON.
6. Les trois barres indiquent l'état de charge des piles.
7. Indique le nombre de plages mémorisé sur le disque, le nombre de plages programmé etc. L'affichage maximum est de 15 plages.
8. Le lecteur est réglé sur [LAST MEMO.].
9. Indique la durée d'enregistrement totale du disque, le temps total écoulé et le temps écoulé sur la plage en cours de lecture.
10. Indique le nombre total des plages musicales du disque et l'ordre dans lequel elles sont programmées et vont être lues.
11. Le lecteur est réglé sur répétition de la lecture.
12. La touche [HOLD] du lecteur est réglée sur ON (Marche).
13. La face A ou B de la bande est indiquée pendant que le lecteur est réglé sur [EDIT].
14. Allumé pendant la lecture ou une opération de recherche et il clignote pendant la pause.

Alimentation électrique

■ Le lecteur est utilisable des deux manières suivantes:

Piles rechargeables (fournies)	Quand elles sont usées, les recharger à l'aide de l'adaptateur de recharge.
Batterie alcaline	Utiliser les piles sèches l'alkali manganèse format AA dans le commerce.
Alimentation électrique domestique	Utiliser l'adaptateur ca fourni.
Batterie automobile	Utiliser l'adaptateur pour batterie automobile DC-C4 fourni en option (batteries de 12 volts uniquement). (Le fabricant décline toute garantie des résultats avec un adaptateur de batterie automobile autre que DC-C4.)

■ Mode d'emploi de l'adaptateur ca fourni <Fig. 4>

- Cet adaptateur permet de raccorder le lecteur à une prise secteur normale. Insérer le jack de l'adaptateur ca dans la prise d'alimentation électrique au dos du lecteur puis raccorder l'adaptateur ca à une prise d'alimentation secteur.
- Quand il n'est pas utilisé, débrancher l'adaptateur de la prise secteur. Avant de brancher ou de débrancher à la source d'alimentation, appuyer deux fois sur la touche "STOP/OFF" pour mettre le lecteur hors tension.

■ Mode d'emploi des piles rechargeables <Fig. 5>

Les seules piles utilisables sont les piles rechargeables (KN-3U) fournies.

Ne pas utiliser d'autres types de piles rechargeables ou des piles sèches au manganèse.

Si ces piles sont utilisées pour la première fois, les mettre en charge pendant huit heures.

● Pour recharger

1. Insérer les piles dans l'adaptateur de recharge fourni en respectant bien la polarité.
2. Raccorder l'adaptateur ca à une prise secteur et brancher le jack de sortie de cet adaptateur à la prise d'alimentation côté 4 V de l'adaptateur de recharge.

● Indicateur d'usure des piles

Quand l'une des trois barres indiquant l'état de charge des piles clignote, les piles sont usées. Les mettre en recharge. Quand les piles sont usées, les trois barres de l'indicateur de durée de vie des piles s'allument et l'indication disparaît.

● Temps de charge

En utilisation normale, une charge de 5 heures assure une durée de vie de 1,5 heures aux piles.

Si celles-ci ne sont pas utilisées pendant une longue période de temps, les mettre en charge pendant environ 8 heures.

● Pour prolonger la durée de vie de la pile

La pile fournie en accessoire ne peut pas être suffisamment rechargée quand elle n'est pas à plat. Dans un tel cas, décharger complètement la pile et ensuite la recharger d'une façon répétitive.

Attention:

- Pour la recharge des piles, n'utiliser que l'adaptateur ca fourni. Tout autre type d'adaptateur peut s'avérer **dangereux**.
- Eviter toute opération de recharge adverse et les court-circuits sous peine de détérioration des piles rechargeables et de dégagement de chaleur.
- Ne pas démonter et modifier le système.
- Après avoir effectué la recharge, enlever les piles de l'adaptateur et débrancher ce dernier de la prise secteur.
- Ne pas toucher au lecteur de CD, à l'adaptateur ca et à l'adaptateur de recharge avec des mains humides.
- Pour l'opération de recharge, n'utiliser que le seul adaptateur de recharge exclusif fourni avec ce lecteur.
- En cas de contact du liquide contenu dans les piles avec la peau ou les vêtements, rincer abondamment à l'eau courante.
- Eviter de laisser les piles en charge pendant plus de 24 heures sous peine de réduction de leur durée de vie.

FRANÇAIS

Pour insérer les piles dans leur compartiment < Fig. 6 >

Ouvrir le couvercle du compartiment des piles.

- ① Soulever le couvercle appuyant sur le bouton d'arrêt (STOP).

Insérer les piles.

- ② Insérer les quatre piles rechargeables fournies ou 4 piles à l'alkali manganèse dans le logement des piles en respectant bien la polarité.

Refermer le couvercle du compartiment.

- ③ Placer la saillie du couvercle en bonne position.
- ④ Appuyer sur le couvercle jusqu'à enclenchement sonore en place et verrouillage.

Durée de vie des piles rechargeables:

Les piles rechargeables ont une durée de vie limitée.

Après environ 500 opérations de recharge, les piles perdent pratiquement la moitié de leur puissance (temps de service) par rapport à des piles neuves. Si les piles perdent de leur puissance bien qu'elles aient été correctement rechargées, les remplacer en achetant quatre piles rechargeables.

Télécommande sans fil <Fig. 7>

Les fonctions des touches du boîtier de télécommande sont identiques à celle des touches du lecteur. Ce boîtier ne permet pas de mettre le lecteur sous tension.

- ① Touche de sélection directe des plages (0 ~ 9) (Télécommande uniquement)
- ② Touche recherche manuelle [◀◀ ▶▶] (Indépendante sur le boîtier de télécommande)
- ③ Touche EDIT (Edition) (Télécommande uniquement)
- ④ Touche REPEAT (Télécommande uniquement)
- ⑤ Touche P. MODE
- ⑥ Touche STOP [■]
- ⑦ Emetteur du signal de télécommande
- ⑧ Touches de sélection directe des plages enregistrées (+ 10) (Télécommande uniquement)
- ⑨ Touche saut [◀◀ ▶▶] (indépendante pour la télécommande)
- ⑩ Touche PLAY/PAUSE [▶/||]
- ⑪ Touche VOLUME DOWN/UP (Volume -/+) (∨ ∩)
- ⑫ Compartiment des piles (Envers)

■ Pour insérer les piles dans leur compartiment

1. Faire glisser le couvercle du compartiment à piles au dos du boîtier de télécommande dans le sens repéré par la flèche et en appuyant légèrement.
2. Insérer les deux piles sèches type AAA dans le compartiment. Bien respecter la polarité des piles indiquée au fond du compartiment à piles.

Précaution:

- Ces piles alimentent les fonctions du boîtier de télécommande. Leur durée de vie risque d'être courte. Quand le boîtier de télécommande doit être tenu très près du lecteur pour fonctionner ou quand il ne répond plus aux commandes, changer les deux piles.

■ Rayon d'action du boîtier de télécommande

Ce rayon d'action est fonction de la température, de l'humidité, de la position d'emploi etc. En principe le boîtier fonctionne au mieux comme illustré ici. La télécommande est impossible si un obstacle sépare le lecteur du boîtier de télécommande.

Précautions:

- Après avoir envoyé une commande depuis le boîtier de télécommande, attendre au moins pendant une seconde avant d'envoyer la suivante et appuyer nettement et fermement sur la touche de commande. Si deux commandes sont envoyées presque simultanément, elles risquent d'être inefficaces.
- Le bon fonctionnement du boîtier de télécommande risque de laisser à désirer si celui-ci est en exposition directe au soleil.

Ecoute par un casque <Fig. 8>

- Raccorder la prise optionnelle au jack "PHONES" (utiliser une mini-fiche stéréo $\phi 3,5$). Toujours couper l'alimentation électrique avant d'insérer ou de retirer le jack.
- Ajuster l'intensité sonore par le bouton VOLUME.

Du fait qu'un disque compact contient très peu de bruit, un son élevé subit peut être mis en sortie si la commande VOLUME est ajustée trop haut; ceci risque d'endommager sérieusement vos oreilles.

Lecture sur une chaîne audio de salon

■ Lecture utilisant la sortie "LINE OUT" <Fig. 9>

- L'alimentation est fournie par l'adaptateur CA fourni.

- Raccorder le câble de connexion audio fourni à la prise "LINE OUT" du lecteur, puis insérer la fiche blanche dans la prise d'entrée (prise AUX) ou dans la prise d'entrée gauche des prises d'entrée CD de l'amplificateur. Régler l'amplificateur sur "AUX" ou "CD". Si le lecteur de CD est raccordé à un lecteur de cassette, raccorder le câble à la prise "LINE IN".
- Régler le volume à l'amplificateur.
- Si le lecteur de CD est raccordé à un lecteur de cassette, régler le volume à l'aide de la commande de volume (REC LEVEL) du lecteur de cassette. Bien vérifier le niveau du volume via un casque branché sur le lecteur de cassette et vérifier l'indication du décibelmètre de ce même lecteur. (Normalement, raccorder le lecteur de CD aux prises CD ou AUX de l'amplificateur et raccorder le lecteur de cassette à la prise d'entrée/sortie de l'amplificateur.)

Précaution:

Avant d'effectuer les connexions, bien mettre l'amplificateur hors tension.

Ne pas raccorder le lecteur de CD à la prise PHONO de l'amplificateur.

■ Lecture utilisant la sortie "DIGITAL OUT" <Fig. 10>

- L'alimentation est fournie par l'adaptateur CA fourni.
- La sortie de "DIGITAL OUT" peut être connectée à l'entrée numérique d'autre équipement audio, par exemple un amplificateur numérique, pour obtenir une meilleure qualité sonore.

Précautions:

- Avant d'effectuer les connexions, bien mettre l'amplificateur hors tension.
- Si le lecteur CD interfère avec la réception radio ou TV, l'éloigner de la radio ou du téléviseur ou débrancher l'alimentation du lecteur CD.
- **Ne jamais raccorder la sortie de la prises "DIGITAL OUT" sur la prise d'entrée analogique d'un amplificateur sinon l'amplificateur ou les haut-parleurs seront endommagés.**
- Les réglages VOLUME (de l'unité principale ou de la télécommande) sont inopérants. Ajuster l'intensité sonore sur l'amplificateur.

FRANÇAIS

Fig. 10

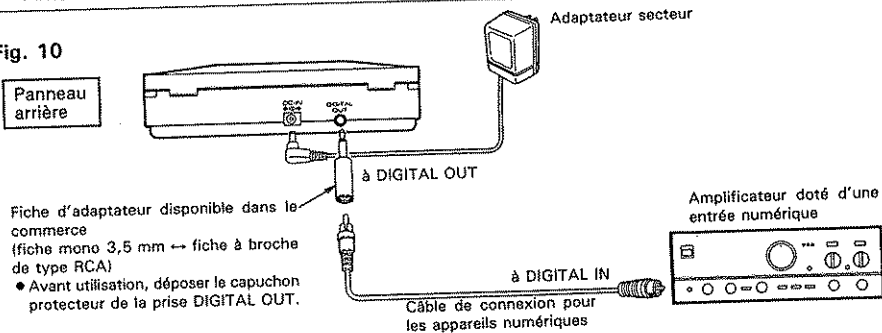

Lecture CD dans une voiture <Fig. 11>

- Si l'alimentation électrique est fournie par l'allume-cigare de la voiture, utiliser l'adaptateur de batterie automobile DC-C4 fourni en option. Cet adaptateur met les piles hors circuit.
- Insérer la fiche de l'adaptateur de l'audio-cassette CAC-1 dans la prise "LINE OUT" du lecteur. Insérer le CAC-1 dans la console des composants et mettre celle-ci en mode marche.
- Régler le volume sur le système audio du véhicule.

Précautions:

- Si cet appareil doit être installé dans une voiture, tenir compte des principes de sécurité et veiller à ce qu'il ne gêne nullement la conduite.
- Le CAC-1 ne peut pas être utilisé avec certains modèles d'autoradio-cassette.
- Ne pas laisser l'appareil dans une voiture fermée si la température risque de monter.
- Placer l'appareil sur un endroit souple où les vibrations de la voiture ne sont pas facilement transmises.
- Si le son est parfois interrompu par des vibrations, mettre la commande de rétention du son [HOLD] en service pour réduire ces interruptions.

Un disque compact à plage unique de 8 cm peut aussi être lu

Cet appareil peut lire les disques compacts à plage unique de 8 cm sans utiliser d'adaptateur.

Précaution:

- Ne pas utiliser d'adaptateurs vendus pour d'autres modèles, sinon le disque compact ou cet appareil risquent d'être endommagés.

Mode lecture (lecture manuelle)

■ Types de lectures

Lecture manuelle	Le disque est lue de la première à la dernière plage (Utilisation élémentaire). (Voir page 26)
Lecture répéter/au hasard	Pour répéter la même plage enregistrée. (Voir page 28)
Lecture directe	Pour choisir une plage donnée. (Voir page 29)
Lecture programmée	Pour choisir une lecture des plages dans un ordre donné. (Voir page 30)

■ Lecture manuelle (utilisation élémentaire)

Mettre d'abord le commutateur HOLD (mise en maintien) sur OFF.

1 Appuyer sur la touche OPEN.

2 Ouvrir le couvercle du lecteur:

Donner une légère impulsion du doigt à côté de la touche OPEN.

3 Insérer le disque: Le texte imprimé sur le disque doit se trouver en haut.

4 Refermer le couvercle.

5 Appuyer sur la touche PLAY/PAUSE (▶/||):

Le lecteur effectue un balayage des données et commence automatiquement la lecture de la première plage du disque.

La touche PLAY/PAUSE a été actionnée pour une mise sous tension.

Le lecteur balaye les données du disque et commence automatiquement la lecture de la première plage.

Si les données ne sont pas lues ou si un disque n'a pas été chargé. (Dans trois minutes, le lecteur sera mis hors tension.)

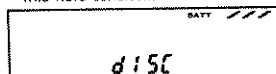
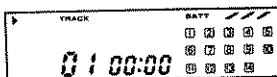

6 Régler le volume.

A la mise sous tension, le volume est réglé sur -20 dB (1/10 du volume maxi.).

■ Mise à l'arrêt provisoire (pause)

⑦ Appuyer sur la touche PLAY/PAUSE [▶/||]:

Appuyer une deuxième fois pour reprendre la lecture à l'endroit même de l'interruption.

■ Mise à l'arrêt

⑧ Appuyer deux fois sur la touche STOP/OFF [■]:

Une seule action sur la touche STOP/OFF [■] met le lecteur en mode d'attente. Appuyer une deuxième fois pour mettre hors tension.

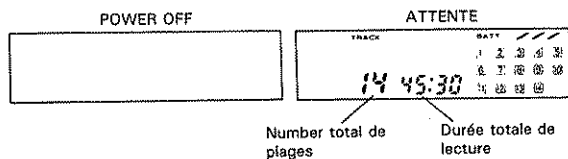

- Quand le lecteur est en mode d'attente depuis plus de 3 minutes, il est automatiquement mis hors tension.

⑨ Indication du temps:

- La touche DISPLAY permet d'afficher les indications suivantes.

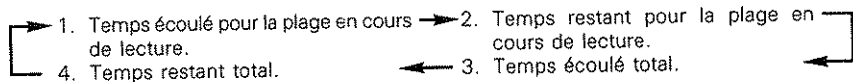

- Pendant le mode de lecture le temps écoulé de la musique en cours est indiqué.

Précautions:

- La touche OPEN efface tous les programmes et met le lecteur hors tension.
- Quand le couvercle est ouvert aucune des fonctions n'est opérative. La fermeture du couvercle ne met pas le lecteur sous tension.
- En mode attente, appuyer sur la touche PLAY/PAUSE [▶/||] pour commencer la lecture du disque à la première plage de musique.
- Lorsque la musique a été reproduite jusqu'à la dernière piste, et que le lecteur s'est automatiquement mis dans le mode d'attente, le temps total d'exécution est indiqué.
- Attention à ne pas insérer le disque à l'envers. La lecture est impossible dans un tel cas.
- Ne jamais placer autre chose qu'un disque sur la platine du lecteur.
- Bien insérer le disque à plat sur la platine sous peine de détérioration.
- Lorsque le commutateur HOLD (mise en maintien) est sur ON, l'appareil ne se met en marche, même si on appuie sur la touche PLAY/PAUSE [▶/||].

■ **Saut au début d'une plage souhaitée (Fonction de saut ◀◀, ▶▶), recherche dans le sens avant ou arrière (Fonction de recherche ◀◀, ▶▶)**

- Pour la fonction saut de plage musicale, appuyer une fois sur la touche et pour la fonction recherche, laisser le doigt sur la touche.
- Pendant la lecture (Utilisation élémentaire ⑤, ⑥) ou mode d'attente (Utilisation élémentaire ⑧).

⑩ **Pour sauter au début de la plage en cours de lecture:**

Appuyer brièvement sur la touche ◀◀.

Pour sauter au début de la plage suivante:

Appuyer brièvement sur la touche ▶▶.

- Pour revenir au début de la plage qui vient d'être lue, appuyer une fois sur la touche ◀◀.
- Pendant la lecture de la dernière plage du disque, appuyer sur la touche ▶▶ pour passer ensuite à la lecture de la première plage.
- La touche ◀◀ renvoie la lecture à la dernière plage du disque.

Toutes les opérations précédentes peuvent être effectuées aussi bien directement sur le lecteur qu'à partir du boîtier de télécommande.

⑪ **Utilisation de la fonction de retour rapide du lecteur:**

Laisser le doigt sur la touche ◀◀.

Utilisation de la fonction d'avance rapide du lecteur:

Laisser le doigt sur la touche ▶▶.

⑫ **Utilisation de la fonction de retour rapide de la télécommande:**

Laisser le doigt sur la touche ◀◀.

Utilisation de la fonction d'avance rapide de la télécommande:

Laisser le doigt sur la touche ▶▶.

- Dès que les touches d'avance ou de retour rapide sont relâchées, le lecteur commence la lecture à cette position.
- La commande de pause interrompt la lecture à l'endroit même où elle est envoyée.

Ces opérations peuvent être effectuées aussi bien directement sur le lecteur qu'à partir du boîtier de télécommande.

Mode lecture (Lecture répétée/au hasard)

■ **Lecture répétée/au hasard (Sauter les opérations ① à ⑥ des instructions d'utilisation élémentaire.)**

- Cette opération ne peut être commandée que depuis le boîtier de télécommande.
- En mode lecture ou attente (Utilisation élémentaire ⑧).

→ A chaque pression de la touche

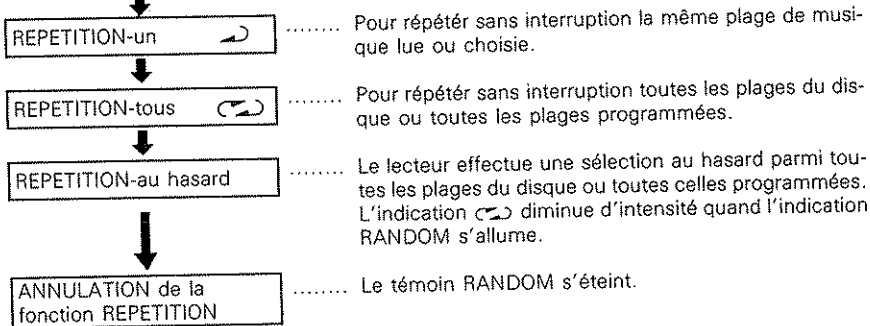

- 13 Pour répéter sans interruption la même plage de musique lue ou choisie:**
Appuyer une fois sur la touche REPEAT.
- 14 Pour répéter sans interruption toutes les plages du disque ou toutes les plages programmées:**
Appuyer deux fois sur la touche REPEAT.
- 15 Pour effectuer la lecture d'une sélection au hasard parmi toutes les plages du disque ou toutes celles programmées:**
Appuyer trois fois sur la touche REPEAT.
Exemple: Si le disque ou le programme contient 7 plages.

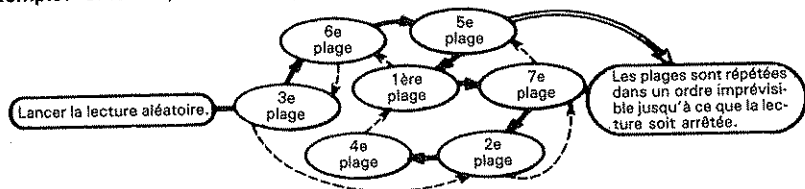

- La fonction de lecture au hasard se répète sans interruption jusqu'à action sur la touche STOP ou annulation du mode répétition.

Précautions:

- Pour passer au mode de lecture au hasard depuis le mode attente, appuyer sur la touche PLAY/PAUSE [▶/||].
- Si le mode de lecture est changé pour une lecture au hasard pendant que la lecture d'une plage de musique est en cours, ce changement devient effectif à la fin de la lecture en cours.
- Pour passer au mode recherche au hasard depuis le mode lecture au hasard, appuyer sur la touche ▶▶.
- Pour répéter la lecture d'une plage en mode lecture au hasard, appuyer sur la touche ◀◀.
- En mode lecture au hasard, les touches 0-9 et +10 sont inefficaces.

Mode lecture (Lecture directe)

■ Lecture directe

(Sauter les opérations 1 à 6 des instructions d'utilisation élémentaire.)

- Cette opération ne peut être commandée que depuis le boîtier de télécommande.
- Appuyer simplement sur la touche correspondant à la plage de musique choisie pour déclencher immédiatement la lecture.
- L'opération peut être commandée en mode lecture ou en mode attente (lecteur à l'arrêt avec un disque sur la platine).
- Tout numéro de plage de musique qui n'existe pas est ignoré.

16 Pour choisir l'une des plages 1 à 9:

Appuyer simplement sur la touche 1 à 9 correspondante.

Pour choisir l'une des plages 10 à 19:

Appuyer d'abord sur la touche +10, puis sur la touche 0 à 9 correspondante.

Pour choisir une plage de numéro 20 ou plus:

Appuyer d'abord deux fois sur la touche +10, puis sur la touche 0 à 9 correspondante.

Pour choisir une plage de numéro 30 ou plus:

Appuyer d'abord deux fois sur la touche +10, puis sur la touche 0 à 9 correspondante.

Mode lecture (Lecture programmée)

- Procéder uniquement depuis le mode attente.
- Cette fonction permet de programmer jusqu'à 24 plages de musique dans n'importe quel ordre.
- Quand la programmation est terminée, appuyer sur la touche PLAY/PAUSE [▶/||] du lecteur ou de la télécommande.

■ Programmation pour une lecture directe

(Sauter les opérations ① à ⑥ des instructions d'utilisation élémentaire.)

⑰ Appuyer sur la touche P.MODE:

- Le lecteur passe en mode programmation.

⑱ Choisir la première plage de musique:

(Utiliser les touches de sélection directe de la télécommande. Voir la marche à suivre en ⑯.)

- Sélectionnez la musique, et la réservation en est faite.

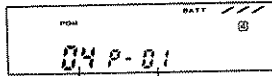

Plage programmée No. de memoire

- Fin de la programmation de la plage 1 (P-01).

⑲ Choisir les plages de musique suivantes (2, 3, ... 24):

- Répéter les opérations de ⑱. On peut faire la réservation de musique l'une après l'autre en répétant la sélection.

⑳ Appuyer sur la touche PLAY/PAUSE [▶/||]: La lecture commence.

- Manipulez la touche LAST MEMO. dans la condition d'OFF.

■ Pour programmer avec la fonction SKIP

(Sauter les opérations ① à ⑥ des instructions d'utilisation élémentaire.)

㉑ Appuyer sur la touche P.MODE:

- Passer en mode de programmation (mêmes opérations qu'en ⑱).
- Sur la télécommande aussi, opérez avec le bouton P.MODE.

㉒ Procéder aux sélections à l'aide de la touche SKIP/SEARCH [◀◀ ▶▶] (Plage 1):

- Avec le boîtier de télécommande, procéder à l'aide de la touche SKIP [◀◀ ▶▶].)
- Mêmes opérations qu'en ⑱ et ㉑.

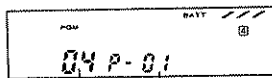

Plage programmée No. de memoire

㉓ Appuyer sur la touche P.MODE.

㉔ Choisir les plages de musique suivantes (2, 3, ... 24):

- Répéter les opérations ㉒ et ㉓.

■ Vérification de la programmation

- Cette fonction doit être effectuée quand la programmation est terminée et que le disque est à l'arrêt.

25 Appuyer sur la touche P.MODE:

- Le numéro de plage de la musique programmée 1 est indiqué.

26 Appuyer à plusieurs reprises sur la touche P.MODE pour:

- Afficher la programmation dans l'ordre des pages.
- Pour revenir à la page 1 après avoir vérifié toute la programmation.

■ Pour modifier une programmation

27 Appeler le numéro de plage à changer dans le numéro du programme concerné en appuyant sur la touche P.MODE:

Exemple:

Pour remplacer la plage 6 par la plage 7 dans le programme 3, appeler ce programme à l'aide de la touche P.MODE.

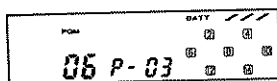

Appuyer sur la touche 7 de la télécommande la plage 6 est remplacée par la plage 7.

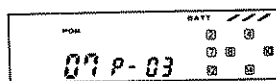

- Il est également possible de changer de plage, en appuyant sur la touche P.MODE, après avoir indiqué la plage 7 à l'aide des touches ◀◀ et ▶▶ de l'unité principale.

■ Pour annuler tous les programmes

28 Mettre le lecteur hors tension ou ouvrir le couvercle:

- Quand la numérotation des plages musicales est affichée et que le disque est à l'arrêt, appuyer une fois sur la touche STOP/OFF pour passer en mode attente. Si le disque est en cours de lecture, appuyer deux fois sur STOP/OFF pour mettre le lecteur hors tension.
- Appuyer sur la touche OPEN.

■ Autres fonctions

- En lecture programmée, le lecteur est en mode espace automatique. Par conséquent, une plage de silence de quatre secondes est insérée entre les plages de musique.
- La lecture programmée, la fonction SKIP ne peut être utilisée que dans les limites des pages programmées.
- Lorsqu'on appelle le programme pendant le mode de programme en attente, et qu'on appuie sur le bouton PLAY/PAUSE (▶/||), LAST MEMO. étant sur OFF (Voir page 34), la lecture commence par la première musique programmée, et non pas par la musique dont le numéro est indiqué à ce moment là.
- Pendant une lecture programmée, la fonction au hasard s'effectue au hasard sur les plages programmées.
- Les touches 0 à 9 et +10 sont inefficaces en lecture programmée.

Fonction EDIT

La fonction EDIT permet d'éditer l'enregistrement d'un CD en fonction de la durée totale de musique enregistrée.

- La sélection des modes EDIT 1, EDIT 2 et EDIT 3 depuis le mode attente se fait en appuyant une, deux ou trois sur la touche EDIT (télécommande uniquement).

■ Mode EDIT 1 (Edition du temps)

- Ce mode permet de régler l'ordre d'enregistrement des plages musicales.

29 Appuyer une fois sur la touche EDIT:

- Cette opération n'est pas possible en mode attente programme.

30 Entrer la durée d'enregistrement de la bande à l'aide des touches 0 à 9 et + 10:

Exemple: Avec une bande 54 minutes:

- 1 Pour entrer la durée de la bande, appuyer 5 fois sur la touche + 10 et une fois sur la touche 4.



- 2 Au bout de 2 secondes, les plages de la face A et le temps restant sur cette face sont indiqués.

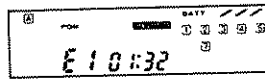

- 3 Au bout de 4 secondes, les plages de la face B et le temps restant sur cette face sont indiqués.

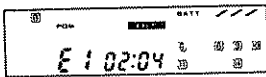

- 4 Au bout de 4 secondes, le lecteur passe en pause au début de la première plage de la face A.



- Choisir les plages enregistrées du CD en fonction du temps alloué par la face A de la bande et choisir une dernière plage en fonction du temps restant.
- Choisir les autres plages enregistrées pour la face B.
- Quand la face A a été enregistrée, l'affichage indique "no-FILE" (plus de fichiers) et le lecteur passe en pause à la première plage de la face A.
- Après lecture de la face A, le lecteur passe en pause au début de la face B.
- A la fin de la face B, le lecteur passe automatiquement en mode attente.

■ Mode EDIT 2 (Edition de programme)

- Ce mode permet de ranger les plages musicales par ordre de préférence.

31 Appuyer deux fois sur la touche EDIT:

32 Choisir les plages de musique voulues à l'aide des touches de sélection directe (0 à 9) (+ 10):

Exemple: Première plage:

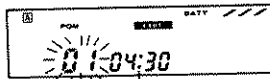

L'indication de la durée de la première plage est indiquée.

Indication du temps écoulé sur la première plage.

33 Appuyer sur la touche P.MODE:

- Le temps accumulé est indiqué.
- Entrer la série de plages choisie en fonction de la durée de la bande et répétant les opérations 32 et 33.

34 Quand la face est terminée, appuyer sur la touche EDIT pour passer à la face B:

- Après lecture de la face B, appuyer sur la touche EDIT pour passer en pause au début de la première plage de la face A.

Precautions:

- Quand la face A est terminée, le lecteur se met en pause à la première plage de la face B.
- Quand la face B est terminée, le lecteur passe en mode d'attente normal.

■ Mode EDIT 3 (Edition en fondu)

- Ce mode permet de procéder à l'édition par des opérations de fondu enchaîné.
- Sortie uniquement au jack PHONE. (Ne fonctionne pas sur LINE OUT.)

35 Appuyer trois fois sur la touche EDIT.

36 Entrer la durée d'enregistrement sur la bande à l'aide des touches de sélection directe (0 à 9) (+ 10).

Exemple: Avec une bande de 60 minutes de long:

- ① Pour entrer la durée de la bande, appuyer 6 fois sur la touche +10 et une fois sur la touche 0.

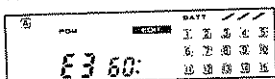

- ② Le temps de fermeture en fondu de la face A est indiqué 2 secondes après.



- ③ Au bout de 4 secondes, c'est la face B qui est indiquée.



- ④ Au bout de 4 secondes, le lecteur passe en pause.

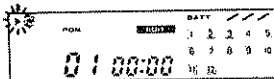

37 Appuyer sur la touche PLAY/PAUSE [▶/||]:

- Le début de l'opération de fondu enchaîné commence 4 secondes après le temps de consigne.

Precautions:

- Quand la face A est terminée, le lecteur passe en pause à la position de début de fondu enchaîné sur la face A, c'est ensuite la face B qui est indiquée.
- Quand la face B est terminée, le lecteur passe en mode d'attente normal.
- Sur la face B, l'opération de début de fondu enchaîné commence à la position de fin de fondu enchaîné de la face A.

Fonction utiles

■ Protection contre les erreurs d'opération [HOLD]/Réduction des sauts de son [Antichoc]/Fonction dernière entrée en mémoire

- Cet appareil est muni d'un fonctionnement HOLD (figé) pour prévenir les opérations erronées, d'un fonctionnement antichoc pour réduire les sauts du son, ainsi que d'un fonctionnement LAST MEMO. pour mémoriser la musique qui était lue avant la coupure du contact. En utilisant le fonctionnement d'antichoc aux endroits sujets aux fortes secousses, comme dans la voiture, les sauts du son sont réduits.

Mettre la fonction retention (HOLD) en service:

- Si la fonction retention (HOLD) est en service, il n'est pas possible de mettre le lecteur sous tension à l'aide de la touche PLAY/PAUSE [▶/||].
- Seule l'opération marche est alors possible depuis le mode attente.
- Si la fonction retention (HOLD) est mise en service pendant une lecture du disque, toutes les touches sauf "OPEN" sont inefficaces.
- Les opérations sont possibles depuis la télécommande même en mode retention.

Lorsque la touche LAST MEMO. est pressée, les opérations suivantes sont obtenues:

- Lorsque l'appareil est mis sous tension à partir de l'état hors tension, il commence par la lecture depuis le début de la musique, au cours de laquelle le pick-up se trouve alors.
- Si, après avoir appuyé sur le bouton STOP/OFF, vous appuyez de nouveau sur le bouton PLAY/PAUSE [▶/||], l'appareil commence par la lecture depuis le début de la musique arrêtée. Quand le lecteur est mis en pause près de la fin d'une plage musicale, la lecture risque de reprendre au début de la plage suivante.
- Lorsqu'on appuie sur le bouton SKIP [◀◀] pendant le mode d'attente, l'appareil commence par la lecture de la musique précédant celle pour laquelle on avait appuyé sur le bouton STOP/OFF.
- Lorsqu'on appuie sur le bouton SKIP [▶▶] pendant le mode d'attente, l'appareil commence par la lecture de la musique suivant celle pour laquelle on avait appuyé sur le bouton STOP/OFF.

■ Témoin de durée de vie des piles

- La puissance disponible des piles (piles rechargeables fournies) est indiquée par trois barres. (Si les piles ne sont pas du type de celles fournies avec le lecteur, les indications affichées risquent de ne pas être correctes.)
- Quand les piles sont pleinement chargées, les trois barres sont visibles. Quand les piles sont en charge normale, seules deux barres sont visibles. Quand une seule barre est visible, celle-ci entre en clignotement. Recharger les piles immédiatement.

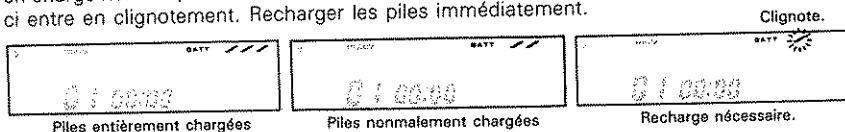

Piles entièrement chargées

Piles normalement chargées

Recharge nécessaire.

FRANÇAIS

■ Fonctionnement de BASS-BOOST

Quand le commutateur BASS-BOOST est sur ON:

- Les sons ultra-bas étant renforcés, on peut goûter les sons bas dynamiques en écoutant avec le casque.
- La mécanique BASS-BOOST ne répond pas aux signaux émis par le jack LINE OUT.

Soins et entretien simples < Fig. 12 >

■ Nettoyage du lecteur

La peinture de ce lecteur est une peinture spéciale.

Ne pas l'essayer avec un chiffon rugueux. Utiliser un chiffon doux. Si nécessaire, humidifier légèrement le chiffon. Essuyer ensuite avec un chiffon sec.

■ Nettoyage de la lentille

Nettoyer la lentille soigneusement avec une brosse d'objectif d'appareil photo du commerce, etc.

■ Soin et entretien des disques

Si de la poussière se trouve sur la surface de lecture d'un disque, le nettoyer soigneusement avec un chiffon de nettoyage de disque compact du commerce, etc. Lors du nettoyage, toujours essuyer dans une direction radiale, comme indiqué dans la Fig. 12. (Ne pas utiliser un nettoyeur de disque pour microsilons.) Eviter de laisser les disques au soleil ou dans un endroit où la température est élevée.

Quand un disque ne doit pas être utilisé pendant longtemps, ne pas le laisser dans le lecteur CD.

Caractéristiques techniques

Système de lecture	Exploration par trois faisceaux	
Type de laser	Laser semiconducteur	
Convertisseur N/A	16 bits, linéaire	
Filtre	Filtre numérique à 8 fois suréchantillonnage	
Réponse de fréquence	De 20 à 20.000 Hz, ± 1 dB	
Distorsion harmonique totale	0,04% (à 1 kHz)	
Rapport S/B	90 dB, 1 kHz	
Séparation des canaux	80 dB, 1 kHz	
Pleurage et scintillement	Inférieur au seuil mesurable	
Bornes de sortie	Prise de casque: prise mini format stéréo, 3,5 mm	
	Prise de sortie de ligne (LINE OUT): prise mini format stéréo, 3,5 mm	
	Prise de sortie numérique (DIGITAL OUT): prise mini format mono, 3,5 mm	
Borne d'entrée	Entrée de courant continu 3 V à 5 V (alimentation externe)	
Niveau de sortie	15 mW + 15 mW (16 Ω , à 1 kHz)	
Sortie de ligne	0,8 V (47 k Ω à 1 kHz)	
Consommation	0,9 W	
Alimentation	Courant continu 3 V: Piles rechargeable incorporée ou prise DC IN externe	
	Secteur 120 V, 60 Hz (modèle pour Etats-Unis et Canada, avec l'adaptateur secteur fourni),	
	220-240 V CA, 50 Hz (Royaume-Uni, Europe, et Australie avec l'adaptateur CA fourni) ou	
	Secteur 110-120/220-240 V, 50/60 Hz (tous les autres modèles, avec l'adaptateur secteur fourni)	
Autonomie de batterie	Env. 1,5 heures (à la lecture répétée en continu) (variable selon les conditions de charge)	
Dimensions (L x H x P)	130 x 34 x 137 mm	
Poids	490 g (sans la Piles rechargeable)	
Accessoires	Cordon de raccordement	x 1
	Adaptateur secteur	x 1
	Adaptateur de recharge	x 1
	Télécommande à infrarouge (RC-P81)	x 1
	Adaptateur d'autoradio-cassette (CAC-1)	x 1
	Pile (AAA)	x 2
	Pile rechargeable (AA)	x 4



KENWOOD poursuit une politique orientée vers un continuel perfectionnement et les présentes caractéristiques peuvent subir des modifications éventuelles sans notification par préavis.

Antes de conectar el adaptador de CA

¡Importante!

EE. UU. y Canadá

Los aparatos enviados a los países mencionados arriba no disponen de selector de tensión alterna y, por lo tanto, las explicaciones sobre tal selector que siguen a continuación no deben tenerse en cuenta.

Todos los demás países

Los adaptadores de CA enviados a los países que no se indican arriba disponen de un selector de tensión alterna situado en la tapa superior. Consultar el párrafo siguiente para ajustar correctamente este selector.

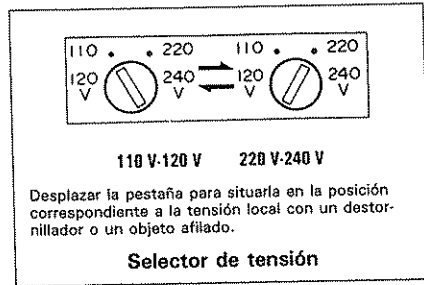

Fig. 1

Antes de enchufar este aparato en la toma de corriente, cerciorarse de que la posición del selector de tensión alterna concuerde con la tensión de la línea. De lo contrario, ponerlo en la posición adecuada. Vea la Fig. 1.

PRECAUCION:

EN MUCHOS CASOS, LA COPIA DE CINTAS O DISCOS SIN PERMISO EXPLICITO DEL AUTOR ESTA PROHIBIDA POR LA LEY. TODO QUIEN DESEE COPIAR CINTAS O DISCOS CON FINES COMERCIALES, SIRVASE DIRIGIRSE A LA SOCIEDAD LIMITADA DE PROTECCION DE DERECHOS MECANICOS O A LA SOCIEDAD LIMITADA DE DERECHOS DE AUTOR.

Selección de tensión alterna

El adaptador de CA funciona con 110 ~ 120 voltios o 220 ~ 240 voltios CA. Antes de conectar el cable de la alimentación en la toma de CA, cerciorarse de que la posición del selector concuerde con la tensión de la línea. De lo contrario, el selector deberá ponerse en la posición adecuada de acuerdo a la siguiente explicación.

Nota:

Nuestra garantía no cubre los daños causados por una CA excesiva de la línea debida a un mal ajuste del conmutador selector de tensión.

PRECAUCION:

PARA EVITAR EL RIESGO DE FUEGO O DESCARGAS ELECTRICAS IMPIDASE QUE EL APARATO SE MOJE O HUMEDEZCA.

Controles, conectores e indicadores <Fig. 2>

- ① **[■]** Botón de parada/desactivación (deconexión de la alimentación) * (STOP/OFF (POWER OFF))
- ② Botón de salto/búsqueda (SKIP/SEARCH) [◀◀ ▶▶]
- ③ Botón de visualización (DISPLAY)
- ④ Botón de modo de programa (P. MODE)
- ⑤ Interruptor de refuerzo de graves (BASS-BOOST)
- ⑥ Botón para disminuir el volumen (VOLUME DOWN)
- ⑦ Botón para aumentar el volumen (VOLUME UP)
- ⑧ Sensor del control remoto por infrarrojos
- ⑨ Botón de reproducción/pausa (PLAY/PAUSE) [▶/||] (POWER ON) *
- ⑩ Presentación visual
- ⑪ Tapa
- ⑫ Botón de apertura (OPEN)
- ⑬ Toma de salida de línea (LINE OUT)
- ⑭ Toma para auriculares (PHONES)
- ⑮ Interruptor de retención/última memoria (HOLD/LAST MEMO.)
- ⑯ Toma de entrada de DC (DC IN, 3 ~ 5 V)
- ⑰ Toma de salida digital (DIGITAL OUT)
- ⑱ Tapa de la batería

* Mientras se está utilizando el adaptador de C.A. o el adaptador para automóvil, la lámpara que existe en el botón [▶/||] y [■] se ilumina para permitir un reconocimiento fácil.

Descripción de la presentación visual <Fig. 3>

1. Esto se indica cuando se exploran los datos del disco.
2. Esto se indica cuando se ajusta el modo de entrada de programa o el modo de compaginación [EDIT].
3. Esto se indica cuando se ajusta la operación de reproducción al azar.
4. Esto se indica mientras el interruptor de refuerzo de graves [BASS-BOOST] está activado (ON).
5. Esto se indica mientras compaginación [EDIT] está activado (ON).
6. Esto indica el consumo de las pilas recargables mediante tres barras.
7. Esto indica el número de surco memorizado en el disco, el número de surco programado, etc. Se indican 15 melodías como máximo.
8. Esto se indica mientras el interruptor de última memoria [LAST MEMO.] está activado (ON).
9. Esto indica el tiempo total de grabación y el tiempo total transcurrido del disco, y el tiempo transcurrido de la melodía que se está reproduciendo.
10. Esto indica el número total de melodías y el orden de las melodías en el disco que se está reproduciendo y programando.
11. Esto se indica mientras se está operando la reproducción repetida.
12. Esto se indica mientras el interruptor de retención [HOLD] está activado (ON).
13. Esto indica ya sea el Lado A o el B de la cinta mientras se ajusta [EDIT].
14. Esto se indica durante la operación de Reproducción o de Búsqueda; esto parpadea durante la operación de Pausa.

Fuente de alimentación

■ Utilice de acuerdo con los métodos que se indican a continuación:

Pilas Recargables (Suministradas)	Utilice después de recargar con el adaptador de recarga suministrado.
Pila de manganeso alcalina	Utilice pilas de manganeso alcalinas tamaño AA que se encuentran disponibles en el mercado general.
Fuente de alimentación doméstica de C.A.	Utilice el adaptador de C.A. suministrado.
Batería del automóvil	Utilice el adaptador opcional para batería de automóvil DC-C4 (exclusivo para automóviles de 12 V). (El fabricante no puede garantizar los efectos resultantes cuando se utiliza un adaptador para batería de automóvil distinto al DC-C4.)

■ **Cómo se utiliza la unidad principal con el adaptador de C.A. suministrado**
< Fig. 4 >

- Cuando se utiliza el adaptador de C.A. suministrado, es posible efectuar la alimentación desde tomacorrientes domésticos. Introduzca la toma del adaptador de C.A. en el terminal de la fuente de alimentación que se encuentra en el lado posterior de la unidad principal conectando, a continuación, el adaptador de alimentación de C.A. a un tomacorriente doméstico.
- Retire el adaptador de C.A. del tomacorriente cuando no esté en uso. Realice la introducción en el terminal de la fuente de alimentación, o la extracción del mismo, después de oprimir el botón de parada/desactivación (STOP/OFF) dos veces con el objeto de desconectar la alimentación de la unidad principal (POWER OFF).

■ Cómo se utiliza la unidad con las pilas recargables suministradas <Fig. 5>

Las pilas utilizables son sólo las pilas recargables suministradas (KN-3U).

No es posible utilizar ni las pilas recargables ni las pilas secas de manganeso que se comercializan usualmente.

Si utiliza las pilas recargables suministradas por primera vez, cárguelas durante ocho horas.

● Cómo se recargan

1. Introduzca las pilas recargables suministradas, con la polaridad correcta, en el adaptador de recarga suministrado.
2. Conecte el adaptador de C.A. suministrado a un tomacorriente doméstico introduciendo, a continuación, la toma de salida del adaptador de C.A. en el terminal de la fuente de alimentación que se encuentra en el lado de 4 V del adaptador de carga con el objeto de activar la recarga.

● Cómo se reconoce el momento en que se debe efectuar la recarga

La vida de las pilas se está agotando si una de las tres barras que existen en el indicador de la unidad, y se utilizan para indicar la vida remanente de las pilas, comienza a parpadear. Es necesario recargar. Si la reproducción se activa cuando las pilas se están agotando, las tres barras del indicador de vida de las pilas se iluminan apagándose, a continuación, toda la indicación.

● Cómo se reconoce la duración de la recarga

En uso normal, 5 horas de recarga permiten una reproducción continua durante 1,5 horas, aproximadamente.

Sin embargo, recárguelas durante 8 horas, si no las ha utilizado durante un período prolongado de tiempo.

● Cómo se prolonga la vida de las pilas

Si las pilas suministradas se recargan en forma repetida, antes de que las mismas se agoten totalmente, no será posible recargar las pilas suficientemente hasta alcanzar la carga máxima. En dicho caso, antes de efectuar la recarga utilice las pilas hasta que las mismas se agoten, lo que permitirá realizar la recarga normal de las mismas.

Precaución:

- Esté seguro de utilizar sólo el adaptador de C.A. suministrado para recargar. Es perigroso utilizar cualquier otro tipo de adaptador de C.A.
- Evite que se produzcan recargas y cortocircuitos perjudiciales. Los mismos causarán problemas tales como el deterioro de las pilas recargables y la generación de calor.
- No lo desarme y modifique Ud. solo.
- Después de completar la recarga, retire las pilas del adaptador de recarga retirando, a continuación, el adaptador de C.A. del tomacorriente.
- No toque ni el reproductor de D.C., ni el adaptador de C.A. ni el adaptador de recarga con las manos húmedas.
- Para recargar, utilice sólo el adaptador de recarga suministrado que es exclusivo para esta unidad.
- Si el líquido contenido en la pila se pone en contacto con su piel, o con su ropa, debido a una rotura, etc., lave con mucha agua corriente, para eliminarlo.
- Evite sobrecargar la pila durante más de 24 horas pues, de lo contrario, se acortará la vida de la misma.

Cómo se introducen las pilas en el compartamiento de las pilas <Fig. 6>

Abra la tapa del compartamiento de las pilas.

- ① Levante la tapa mientras oprime el botón de STOP.

Introduzca las pilas.

- ② Introduzca, en forma segura, las cuatro pilas recargables o las pilas de manganeso alcalino suministradas en el compartimiento de las pilas, prestando atención a la polaridad correcta.

Cierre la tapa del compartimiento de las pilas.

- ③ Coloque el gancho de la tapa del compartimiento de las pilas en la posición especificada.
④ Esté seguro de colocarlo en la posición especificada hasta que se escuche un chasquido y quede trabado.

Vida útil de las pilas recargables:

La vida útil de las pilas recargables es limitada.

Después de 500 recargas, aproximadamente, el rendimiento (tiempo de operación) de las mismas se reduce a la mitad en comparación con pilas nuevas. Si el tiempo de operación se acorta considerablemente, aunque Ud. haya cargado sus pilas en forma correcta, compre cuatro pilas recargables, reemplazarlas.

Unidad de control remoto inalámbrica <Fig. 7>

La función de cada interruptor es similar a la de los interruptores que existen en la unidad principal. La operación de conexión de la alimentación (POWER ON) no es posible con el controlador remoto.

- ① Botones de selección directa de melodías (0 ~ 9) (Control remoto solamente)
- ② Botón de búsqueda manual [◀◀▶▶] (independiente para el control remoto)
- ③ Botón de compaginación (EDIT) (Control remoto solamente)
- ④ Botón de repetición (REPEAT) (Control remoto solamente)
- ⑤ Botón de modo de programa (P.MODE)
- ⑥ Botón de parada (STOP) [■]
- ⑦ Transmisor de señales de control remoto
- ⑧ Botón de selección directa de melodías (+ 10) (Control remoto solamente)
- ⑨ Botón de salto [◀◀▶▶] (independiente para el control remoto)
- ⑩ Botón de reproducción/pausa (PLAY/PAUSE) [▶/||]
- ⑪ Botón para disminuir/aumentar el volumen (VOLUME DOWN/UP) (◁ ▷)
- ⑫ Compartimiento de las pilas (Lado revés)

■ Cómo se introducen las pilas en el compartimiento de las pilas

1. Aplicando una ligera presión sobre la tapa, que se encuentra en el lado posterior del compartimiento de las pilas, haga que la misma se deslice en el sentido indicado por la flecha.
2. Introduzca, en el compartimiento de las pilas, las dos pilas secas tamaño AAA suministradas. Coloque correctamente las pilas en la posición especificada de acuerdo con la indicación de polaridad que se encuentra en el fondo del compartimiento de las pilas.

Nota:

- Las pilas secas suministradas se utilizan para verificar las acciones del controlador remoto. Observe que la vida de las mismas puede ser corta. Cuando la distancia efectiva controlable en forma remota se reduce o el controlador remoto deja de funcionar, reemplace ambas pilas por otras nuevas.

■ Distancia efectiva de operación del controlador remoto

La misma varía con condiciones tales como la temperatura, la humedad, el lugar en que se utiliza, etc. Sin embargo, cumple básicamente con lo que se muestra en la ilustración siguiente. Si existe una obstrucción cualquiera entre la unidad principal y el controlador remoto, éste no funciona correctamente.

Notas:

- Cuando deba oprimir la tecla de la operación siguiente después de oprimir una tecla de operación en el controlador remoto espere, por lo menos, un segundo oprimiéndola, entonces, de manera segura y uniforme. Si Ud. oprime la tecla de la operación siguiente inmediatamente después de oprimir una tecla de operación, es posible que no funcione correctamente.
- Es posible que no funcione correctamente en un lugar en el que se encuentre expuesto a los rayos directos del sol.

Utilización de auriculares <Fig. 8>

- Introduzca la clavija de los auriculares opcionales en la toma "PHONES" (utilice una clavija mini estéreo de 3,5 mm de diámetro). Realice la operación de introducción en la toma, y extracción de la misma, mientras la Alimentación está desconectada (OFF).
- Ajuste el volumen con el botón VOLUME.

Como los discos compactos apenas producen ruidos, si ajusta el control VOLUME demasiado alto puede producirse un sonido muy alto que podría dañar sus oídos.

Reproducción a través de un sistema de audio del hogar

■ Reproducción utilizando la salida "LINE OUT" <Fig. 9>

- La alimentación eléctrica se suministra a través del adaptador de CA provisto.
- Conecte el cable de conexión de audio suministrado a la salida de línea (LINE OUT) de la unidad principal introduciendo, a continuación, el enchufe blanco en el terminal de entrada externo (terminal AUX) del amplificador o el terminal de entrada izquierdo de los terminales de entrada CD. Coloque el selector de entrada del amplificador en "AUX" o en "CD". Cuando se va a realizar la entrada desde la unidad principal a un magnetófono, conecte el cable al terminal de entrada de línea.
- Ajuste el volumen entre los amplificadores.
- Cuando se va a realizar la entrada directa desde la unidad principal al magnetófono, ajuste el volumen con el ajustador de nivel de volumen del magnetófono. En este caso, esté seguro de confirmar el volumen por medio del auricular conectado al magnetófono y el indicador de nivel pico del magnetófono. (En general, conecte la unidad principal al terminal CD o al terminal AUX del amplificador, y conecte el magnetófono al terminal de entrada/salida de cinta del amplificador).

Precaución:

Antes de hacer conexiones cerciórese de que el amplificador esté apagado.

No conecte la unidad principal al terminal PHONO del amplificador.

■ Reproducción utilizando la salida "DIGITAL OUT" <Fig. 10>

- La alimentación eléctrica se suministra a través del adaptador de CA provisto.
- La salida de "DIGITAL OUT" puede conectarse en la entrada digital de otro equipo de audio -un amplificador digital por ejemplo- para obtener un sonido de alta calidad.

Notas:

- Antes de hacer conexiones cerciéndose de que el amplificador esté apagado.
- Si el reproductor de discos compactos interfiere con la recepción de la radio o televisor, separe el reproductor de discos compactos de la radio o del televisor, o apague el reproductor de discos compactos.
- **No conecte nunca la salida de la toma "DIGITAL OUT" en la toma de entrada analógica de un amplificador porque de lo contrario podrían estropearse el amplificador o los altavoces.**
- Los botones VOLUME (del aparato principal o del mando a distancia) quedan inhabilitados. Ajuste el volumen con el amplificador.

Fig. 10

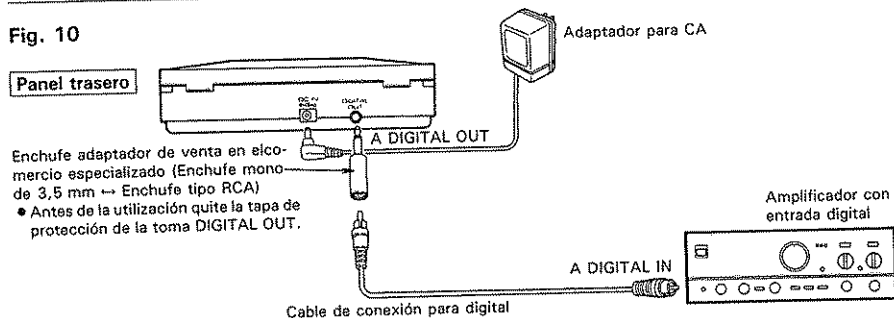

Reproducción de discos compactos en un automóvil

< Fig. 11 >

- Cuando la alimentación se toma desde el encendedor de un automóvil, utilice el adaptador opcional para batería de automóvil DC-C4. El mismo le permite disfrutar escuchando música durante un período prolongado sin preocuparse por el consumo de las pilas.
- Introduzca la clavija del adaptador para equipos de audio de automóviles CAC-1 en el terminal de salida de línea (LINE OUT) de la unidad principal. Introduzca el CAC-1 en el magnetófono del automóvil del automóvil, y coloque el magnetófono del automóvil en el modo de reproducción.
- Ajuste el volumen en el lado de audio del automóvil.

Notas:

- En caso de utilizar el aparato en un automóvil, instálelo poniendo máxima atención a la seguridad. No lo ponga en un lugar donde interfiera con las operaciones de conducción.
- El CAC-1 no puede utilizarse con algunos equipos de audio de automóvil.
- No deje ni la unidad ni el Controlador Remoto en el la temperatura alcanzará un valor elevado.
- Ponga el aparato sobre un lugar blando donde no puedan llegar las vibraciones producidas por el automóvil.
- Si se produce algún salto de sonido debido a las vibraciones, active el interruptor de retención [HOLD] para reducir el salto de sonido.

También puede reproducirse un disco compacto de 8 cm

Este aparato puede reproducir directamente discos compactos de 8 cm.

Precaución:

- No utilizar un adaptador vendido para otros modelos porque de lo contrario, el disco compacto o este aparato se estropearán.

Cómo se reproduce (Reproducción manual)

■ Clases de reproducción

Reproducción manual	Reproduce melodías desde el primer surco hasta el último (operación básica). (Vea la Página 42.)
Reproducción repetida/ Reproducción al azar	Reproduce su melodía favorita en forma repetida. (Vea la Página 44.)
Reproducción directa	Selecciona su melodía favorita. (Vea la Página 45.)
Reproducción programada	Reserve sus melodías favoritas en el orden deseado. (Vea la Página 45.)

■ Reproducción manual (Operación básica)

Deje el interruptor de retención (HOLD) desactivado (OFF).

- 1 Oprima el botón de apertura (OPEN).
- 2 Abra la tapa: Levante ligeramente la tapa en las proximidades del botón de apertura (OPEN).
- 3 Introduzca el disco:
Esté seguro de mantener el lado con rótulo del disco dirigido hacia arriba.
- 4 Cierre la tapa.
- 5 Oprima el botón de reproducción/pausa (PLAY/PAUSE [▶/||]):

La unidad comienza automáticamente la reproducción después de explorar los datos del disco.

Cuando se oprime el botón de reproducción/pausa (PLAY/PAUSE) para conectar la alimentación.

Cuando la unidad explora los datos del disco y comienza automáticamente la reproducción.

En el caso de que no se lean datos o no se introduzca un disco. (La alimentación se desconectará después de que hayan transcurrido tres minutos.)

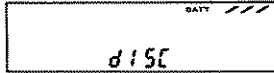
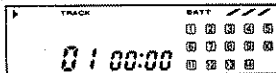
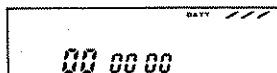

6 Ajuste el volumen:

Mientras la Alimentación está conectada (ON), se ajusta a un valor de -20 dB (1/10 del volumen máximo).

■ Para operar la parada momentánea (pausa)

7 Oprima el botón de reproducción/pausa (PLAY/PAUSE [▶/||]):

Si Ud. lo oprime más de una vez, la unidad comienza la reproducción desde la posición en que se interrumpió momentáneamente la reproducción.

■ Para parar

8 Oprima el botón de parada/desactivación (STOP/OFF [■]) dos veces:

Si el botón de parada/desactivación (STOP/OFF [■]) se oprime una vez, la unidad pasa al modo en espera. Si se oprime otra vez, la alimentación de la unidad se desconecta (POWER OFF).

POWER OFF

Mode en espera

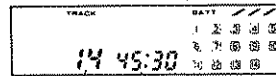

Número total de melodías Tiempo de reproducción total

- Si el modo en espera se prolonga durante más de 3 minutos la alimentación de la unidad se desconecta (POWER OFF).

9 Indicación del tiempo:

- Cuandoquiera que se oprime el botón de visualización (DISPLAY), se presentan las siguientes indicaciones.

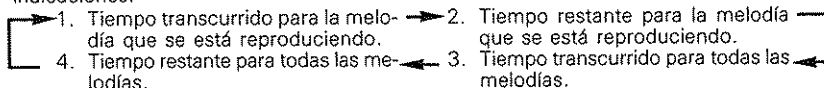

- Durante en el modo de reproducción, se indica el tiempo transcurrido de la melodía que se está reproduciendo.

Notas:

- Si se oprime el botón de abertura (OPEN), todo el contenido se borra y la alimentación de la unidad se desconecta (POWER OFF).
- Si la tapa está abierta, ninguna de las funciones operará. El cierre de la tapa no sólo permite que se conecte la alimentación de la unidad.
- Si se oprime el botón de reproducción/pausa (PLAY/PAUSE [▶/||]) durante el modo en espera, la unidad comienza la reproducción desde el primer surco.
- Cuando la melodía se reproduce hasta el surco final y el reproductor pasa naturalmente al Modo en Espera, indica el tiempo de reproducción total.
- Está seguro de no introducir el disco al revés. Si el disco se introduce al revés en la unidad, ésta no puede comenzar la reproducción.
- No introduzca, en la bandeja para discos, ningún objeto que no sea un disco.
- El disco se puede dañar si se introduce en forma diagonal en la bandeja para discos.
- Si el interruptor de retención (HOLD) se activa (ON), no será posible activar la operación de reproducción/pausa (PLAY/PAUSE [▶/||]) aunque se oprima el botón.

■ Para saltar al comienzo de la melodía deseada (función de salto ◀◀, ▶▶) para buscar melodías en la dirección de avance o retroceso (función de búsqueda, ◀◀, ▶▶)

- La función de salto se activa cuando se oprime el botón una vez, y la función de búsqueda se activa cuando se oprime el botón en forma continua.
- Opere durante el modo de reproducción (Operaciones básicas (5), (6)), o en espera (Operación básica (8)).

⑩ Para saltar al comienzo de la melodía que está siendo reproducida:

Pulse por un instante el botón ◀◀.

Para saltar al comienzo de la siguiente melodía:

Pulse por un instante el botón ▶▶.

- Cuando desee retroceder hasta la melodía anterior, oprima otra vez el botón ◀◀.
- Si se oprime el botón ▶▶ mientras se está reproduciendo la última melodía, hará que se reproduzca la primera melodía.
- Si oprime el botón ◀◀ durante el modo en espera, se activará la última melodía para reproducción.

Las operaciones que se mencionan precedentemente son comunes a la unidad principal y al controlador remoto.

⑪ Cómo se opera el retroceso rápido con la unidad principal:

Oprima el botón ◀◀ en forma continua.

Cómo se opera el avance rápido:

Oprima el botón ▶▶ en forma continua.

⑫ Cómo se opera el retroceso rápido con el controlador remoto:

Oprima el botón ◀◀ en forma continua.

Cómo se opera el avance rápido: Oprima el botón ▶▶ en forma continua.

- Si Ud. libera los botones de retroceso rápido y de avance rápido, la unidad reproducirá la melodía a partir de dicha posición. Si, durante el modo de pausa, se realiza una operación, la melodía se interrumpirá momentáneamente en la posición en que se libera el botón.

Las operaciones antes mencionadas son comunes para la unidad principal y el controlador remoto.



Cómo se reproduce (Reproducción repetida/Reproducción al azar)

■ Reproducción repetida/Reproducción al azar

(Se omiten las operaciones básicas ① - ⑥.)

- Esta función se puede operar sólo por medio del controlador remoto.
- Opere durante el modo de reproducción o en espera (operación básica ⑧).

→ Cada vez que se oprime el botón

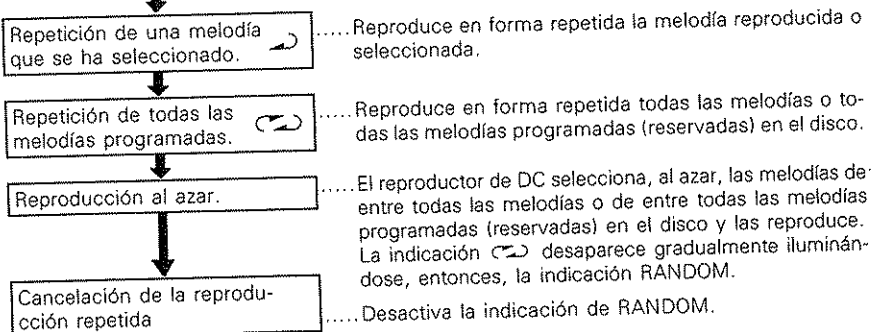

⑬ Cómo se reproduce en forma repetida la melodía que se está reproduciendo o se ha seleccionado:

Oprima el botón de repetición (REPEAT) una vez.

⑭ Cómo se reproducen en forma repetida todas las melodías o todas las melodías programadas en el disco:

Oprima el botón de repetición (REPEAT) dos veces.

⑮ Cómo se seleccionan al azar las melodías de entre todas las melodías o de entre todas las melodías programadas en el disco y se reproducen:

Oprima el botón de repetición (REPEAT) tres veces.

Ejemplo: En el caso de selección de 7 melodías

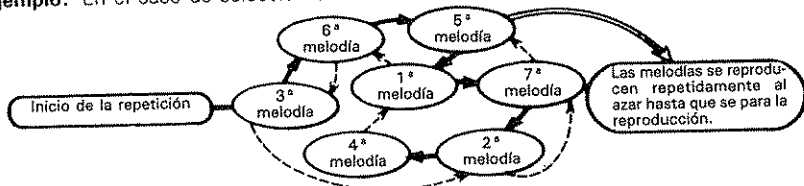

- La operación de reproducción al azar se repite en forma indefinida a menos que se oprima el botón de parada (STOP), o se cancele el modo de repetición.

Notas:

- Si el modo se cambia a modo al azar durante el modo en espera, y se oprime el botón de reproducción/pausa (PLAY/ PAUSE (▶/||)), se activa el modo de búsqueda al azar.
- Si el modo se cambia a modo al azar durante la operación de reproducción, el modo pass a modo de búsqueda al azar cuando finaliza la melodía que se está reproduciendo.
- Si se oprime el botón ▶▶ durante la reproducción al azar, el modo pass a modo de búsqueda al azar.
- Si se oprime el modo ◀◀ durante la reproducción al azar, se reproduce nuevamente la melodía que se está reproduciendo.
- Durante la reproducción al azar, no es posible operar los botones 0-9 y +10.

Cómo se reproduce (Reproducción directa)

■ Reproducción directa (Se omiten las operaciones básicas 1 - 6.)

- Esta función se puede operar sólo por medio del controlador remoto.
- La melodía seleccionada se reproduce inmediatamente, con sólo oprimir el botón de selección directa de melodías.
- La operación se puede realizar durante el modo de reproducción o en espera (cuando la unidad está detenida con un disco introducido en la misma).
- No se aceptará la selección de un número mayor que el número de melodías en el disco.

16 En el caso de seleccionar cualquiera de las melodías 1 a 9:

Oprima cualquiera de los botones 1 a 9.

En el caso de seleccionar cualquiera de las melodías 10 a 19:

Oprima cualquiera de los botones 0 a 9 después de oprimir el botón +10.

En el caso de seleccionar cualquiera de las melodías 20 o mayor:

Oprima cualquiera de los botones 0 a 9 después de oprimir el botón +10 dos veces.

En el caso de seleccionar cualquiera de las melodías 30 o mayor:

Oprima cualquiera de los botones 0 a 9 después de oprimir el botón +10 tres veces.

Cómo se reproduce (Reproducción programada)

- Opere durante el modo en espera. No se puede operar si el modo es distinto al modo en espera.
- Es posible programar (reservar) 24 melodías favoritas en el orden en que desee escucharlas.
- Después de completar la programación (reserva), la reproducción se activa si se oprime el botón de reproducción/pausa (PLAY/PAUSE [▶/||]) (en la unidad principal o en el controlador remoto).

■ Cómo se programa con el botón de selección directa de melodías

(Se omiten las operaciones básicas 1 - 6.)

17 Oprima el botón de modo de programa (P. MODE):

- Pasa al modo de entrada de programa.

18 Seleccione la melodía:

Seleccione la melodía con el botón de selección directa de melodías que se encuentra en el controlador remoto. Siga el procedimiento que se indican en 16. La reserva se completa seleccionando la melodía.

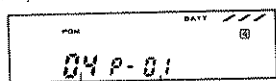

Melodía programada Número de memoria

- Finalización de la reserva de la melodía 1 (P-01).

19 Seleccione la melodía (de entre las melodías 2, 3, ... 24):

- Repita la operación que se indica en 18. Es posible realizar una reserva tras otra repitiendo la selección de melodías.

20 Oprima el botón de reproducción/pausa (PLAY/PAUSE [▶/||]):

Comienza la reproducción

- Opere con el interruptor de última memoria (LAST MEMO.) en la condición desactivada (OFF).

■ Cómo se programa con el botón de salto

(Se omiten las operaciones básicas (1) - (6).)

(21) Oprima el botón de modo de programa (P. MODE):

- Pasa al modo de entrada de programa (operación similar a la que se indica en (18)).
- Opere también con el botón de modo de programa (P.MODE) en el controlador remoto.

(22) Seleccione con el botón de salto/SÍ/SELECCIÓN (SKIP/SEARCH [◀▶▶▶]) (Melodía 1):

- (En el controlador remoto, seleccione con el botón de salto [◀▶▶▶]).
- Operación similar a la que se indica en (10) y (11).

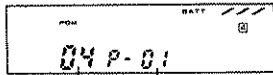

Melodía programada Número de memoria

(23) Oprima el botón de modo de programa (P. MODE).

(24) Seleccione la melodía (de entre las melodías 2, 3, ... 24):

- Repita la operación indicada en (22) y (23).

■ Confirmación del contenido del programa

- Es posible operar esta función cuando el disco ha sido programado y está detenido.

(25) Oprima el botón de modo de programa (P. MODE):

- Indica el número de melodía de la Melodía 1.

(26) Si se oprime el botón de modo de programa (P. MODE) en forma repetida:

- En este caso se indica el contenido programado en orden.
- Cuando se indica el orden de las melodías hasta la última melodía programada, la indicación vuelve a la Melodía 1.

■ Cómo se cambia el contenido del programa

(27) Llame el número del programa a cambiar oprimiendo el botón de modo de programa (P. MODE):

Ejemplo:

Cuando desee cambiar la melodía en el surco 6 del programa número 3 al surco 7, llame el programa número 3 oprimiendo el botón de modo de programa (P. MODE).

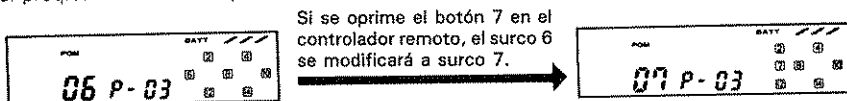

- Ud. puede también modificar el surco después de indicar el surco 7 con los botones ◀▶▶▶ y ▶▶▶▶ que se encuentran en la unidad principal oprimiendo, entonces, el botón de modo de programa (P. MODE).

■ Cómo se cancelan todos los programas

(28) Desconecte la alimentación de la unidad (POWER OFF) o abra la tapa:

- Oprima el botón de parada/desactivación (STOP/OFF) una vez cuando se han programado las melodías y el disco se ha detenido con el objeto de que la unidad pase al modo en espera, u oprima el botón de parada/desactivación (STOP/OFF) dos veces durante la reproducción para que se desconecte la alimentación de la unidad (POWER OFF).
- Oprima el botón de apertura (OPEN).

■ Otras funciones

- La unidad se encuentra, durante la reproducción programada, en el modo de espaciado automático. En dicho caso, entre las melodías se inserta una pausa de cuatro segundos.

- Si durante la reproducción programada se oprime el botón de salto (SKIP), es posible realizar la búsqueda rápida sólo con el surco programado.
- Cuando se llama el programa durante el Modo de Programa en Espera y se oprime el botón de reproducción/pausa (PLAY/PAUSE [▶/⏸]) con la última memoria (LAST MEMO.) desactivada (OFF) (vea la Página 49), el reproductor reproducirá a partir de la primera melodía programada, y no de la melodía cuyo número se está indicando en ese momento.
- La operación al azar durante la reproducción programada busca los números de surcos programados al azar.
- No es posible operar los botones 0~9 y +10 durante la reproducción programada.

Función de compaginación (EDIT)

La función de compaginación (EDIT) permite compaginar, cuando se está copiando un disco compacto en una cinta, aprovechando al máximo el tiempo disponible para grabación de la cinta.

- En el modo en espera, Ud. puede seleccionar los modos de compaginación 1 (EDIT 1), compaginación 2 (EDIT 2) y compaginación 3 (EDIT 3) oprimiendo, respectivamente, una, dos o tres veces el botón de compaginación (EDIT) (en el controlador remoto únicamente).

■ Modo de compaginación 1 (EDIT 1) (Compaginación del tiempo)

- Este es el modo para compaginar de acuerdo con la duración de la cinta.

29 Oprima una vez el botón de compaginación (EDIT):

- En el modo de programa en espera, no es posible realizar esta operación.

30 Entre el tiempo disponible de la cinta con los botones de selección directa de melodías (0~9) y (+10):

Ejemplo: En el caso de una cinta de 54 minutos de duración:

- 1 Oprima 5 veces el botón +10 y una vez el botón 4 para entrar el tiempo disponible de la cinta.
- 2 En 2 segundos, se indicarán los programas en el Lado A y el tiempo restante de la cinta.

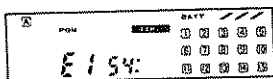

- 3 En 4 segundos, se indicarán los programas en el Lado B y la duración restante de la cinta.

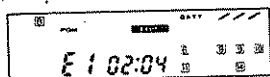

- 4 En 4 segundos, se activa la pausa en la primera melodía del Lado A.

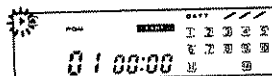

- Ordene las melodías desde la melodía inicial de un disco compacto en forma tal de acomodarlas dentro del tiempo disponible designado del Lado A de un cassette y seleccione, como última melodía, la melodía más adecuada dentro del tiempo restante del mismo.
- Ordene las melodías para el Lado B excluyendo las melodías programadas para el Lado A y seleccione, como última melodía del Lado B, la melodía más adecuada.
- Cuando todas las melodías se han grabado en el Lado A, en la visualización se indica "no-FILE" y se activa la pausa en la primera melodía del Lado A.
- Después de que se completa el Lado A, la pausa se activará en la parte inicial del Lado B.
- Cuando se completa la operación de reproducción hasta el final del Lado B, se activa en forma automática el modo en espera normal.

■ Modo de compaginación 2 (EDIT 2) (Compaginación de Programa)

- Este es el modo para compaginar seleccionando sus melodías favoritas.

31 Oprima dos veces el botón de compaginación (EDIT).

32 Seleccione las melodías que desea escuchar con el botón de selección directa de melodías (0~9) (+10):

Ejemplo: La primera melodía:

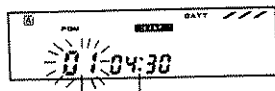

La indicación de la primera melodía está parpadeando. La indicación del tiempo transcurrido de la primer melodía.

33 Oprima el botón de modo de programa (P.MODE):

- Se indicará el tiempo acumulado.
- Entre cualesquiera melodías que Ud. desee, adaptando el tiempo acumulado a la cinta y repitiendo el procedimiento que se indica en los pasos 32 y 33.

34 Oprima el botón de compaginación (EDIT) después de que se completa el Lado A con el fin de hacer una entrada en el Lado B:

- Si se oprime el botón de compaginación (EDIT) otra vez después de que se completa el Lado B, la pausa se activará en la primera melodía del Lado A.

Notas:

- Cuando se completa el Lado A, se activa la pausa en la sección inicial del Lado B.
- Cuando se completa el Lado B, se activa el modo en espera normal.

■ Modo de compaginación 3 (EDIT 3) (Compaginación con variación gradual en el tiempo)

- Este es el modo de compaginación en base a las operaciones de aumento gradual y reducción gradual.
- Se entrega sólo desde la toma PHONES. (No opera en LINE OUT.)

35 Oprima tres veces el botón de compaginación (EDIT):

36 Entre el tiempo disponible de la cinta con los botones de selección directa de melodías (0~9) y (+ 10):

Ejemplo: En el caso de una cinta de 60 minutos de duración:

- ① Oprima 6 veces el botón +10 y una vez el botón 0 con el objeto de entrar el tiempo disponible de la cinta.

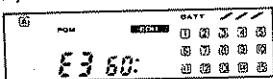

- ③ En 4 segundos, se indica el Lado B.



- ② El tiempo de reducción gradual del Lado A se indica 2 segundos más tarde.



- ④ En 4 segundos, se activa la pausa.

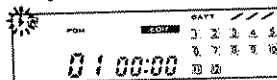

37 Oprima el botón de reproducción/pausa (PLAY/PAUSE ►/||):

- La operación de reducción gradual comienza 4 segundos antes del tiempo ajustado.

Notas:

- Cuando se completa el Lado A, se activa la pausa en la posición inicial de la reducción gradual del Lado A indicándose, entonces, el Lado B.
- Cuando se completa el Lado B, se activa el modo en espera normal.
- En el Lado B, la operación de aumento gradual comienza a partir de la posición de reducción gradual del Lado A.

Funciones convenientes

■ Prevención de una operación incorrecta (Retención) (HOLD)/ Reducción del salto de sonido (Antigolpe)/Función de Última Memoria

- Esta unidad posee la función de retención (HOLD) para evitar una operación incorrecta, la función antigolpe para reducir el salto de sonido y la función de última memoria (LAST MEMO.) para memorizar las melodías hasta que se desconecta la alimentación. Cuando se utiliza la unidad en un automóvil o en otro lugar en el que se producen grandes vibraciones, se reduce el salto de sonido.

Active el interruptor de retención (HOLD):

- Si se activa el interruptor de retención (HOLD) en el modo de alimentación desconectada (POWER OFF), la unidad no pasará al modo de alimentación conectada (POWER ON) aunque se oprima el botón de reproducción/pausa (PLAY/PAUSE ►/||).

- La operación de reproducción sólo se acepta durante el modo en espera.
- Si el interruptor de retención (HOLD) se activa durante la reproducción, no es posible operar ningún interruptor de botón salvo el botón de abertura (OPEN).
- Es posible realizar la operación desde el controlador remoto aún en el modo de retención (HOLD).

Las siguientes operaciones se efectúan al activar el interruptor de última memoria (LAST MEMO.):

- Cuando se conecta la alimentación a partir de la condición desconectada, el reproductor comienza a reproducir la melodía a partir de la parte inicial de la melodía en donde se lee la posición actual del lector.
- Si se oprime el botón de parada/desactivación (STOP/OFF) y se oprime nuevamente el botón de reproducción/pausa (PLAY/PAUSE [▶/||]), el reproductor comienza a reproducir a partir del comienzo de la melodía que se detuvo. (Cuando existe una pausa cerca del fin de una melodía, puede comenzar a reproducir desde la parte inicial de la melodía siguiente.)
- Si se oprime el botón de salto [◀◀] durante el Modo en Espera, el reproductor comienza a reproducir la melodía anterior a la melodía para la cual se oprimió el botón de parada/desactivación (STOP/OFF).
- Si se oprime el botón de salto [▶▶] durante el Modo en Espera, el reproductor comienza a reproducir la melodía siguiente a la melodía para la cual se oprimió el botón de parada/desactivación (STOP/OFF).

■ Indicador de la vida de las pilas

- La vida de las pilas se indica mediante tres barras, suponiendo que se utilizan, como patrón, las pilas recargables suministradas. (No se producirá la indicación correcta si se instalan pilas diferentes a las pilas suministradas.)
- Si las pilas están totalmente cargadas se indican tres barras. Si las pilas están cargadas normalmente se indican dos barras. Cuando se indica una sola barra, la indicación cambia de iluminación continua a parpadeante. En dicho caso, recargue las pilas inmediatamente.

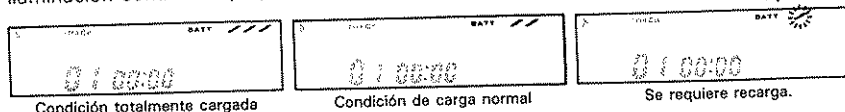

■ Función de refuerzo de graves (BASS-BOOST)

Quando se activa (ON) el interruptor de refuerzo de graves (BASS-BOOST):

- Cuando escuche por los auriculares, Ud. puede disfrutar escuchando con un sonido ultragrave reforzado una melodía con un sonido grave dinámico.
- La función de refuerzo de graves (BASS-BOOST) no funciona contra las señales que salen de la toma de salida de línea (LINE OUT).

Mantenimiento y cuidados sencillos <Fig. 12>

■ Cuando limpie el gabinete

Como esta unidad ha sido pintada de manera especial, no la frote fuertemente con paños duros, etc. Elimine la suciedad frotando el gabinete con un paño suave. Si la mancha está muy adherida y no se pueda eliminar con un paño suave, humedezca el paño con una pequeña cantidad de agua. A continuación, elimine la mancha con este paño humedecido. Está segura de frotar nuevamente con un paño seco para eliminar la humedad.

■ Limpieza de la lente

Limpie cuidadosamente la lente con un soplador para limpiar objetivos de cámara de venta en el comercio especializado, etc.

■ Cuidado y mantenimiento de los discos

Si se adhiere polvo o suciedad en la superficie de reproducción de un disco, límpiela cuidadosamente mediante un paño de limpieza de discos compactos de venta en el comercio especializado, etc.

Cuando limpie el disco, pase el paño en dirección radial, como se muestra en la Fig. 12. (No trata de limpiarlo como si se tratase de un disco normal.)

Evite dejar los discos bajo los rayos directos del sol o en lugar donde la temperatura sea alta. Cuando no vaya utilizar un disco durante largos periodos de tiempo, no lo deje en el interior del reproductor de discos compactos.

Especificaciones

Sistema de seguimiento	Seguimiento de tres rayos
Tipo de láser	Láser semiconductor
Convertidor D/A	16 bits, lineal
Filtro	Filtro digital de sobremuestreo de 8 veces
Respuesta de frecuencia	20 a 20.000 Hz, ± 1 dB
Distorsión armónica total	0,04% (a 1 kHz)
Relación señal a ruido	90 dB, 1 kHz
Separación de canales	80 dB, 1 kHz
Fluctuación y trémolo	Menos del límite mensurable
Terminales de salida	Toma para auriculares: minitoma estéreo de 3,5 mm Toma LINE OUT: minitoma estéreo de 3,5 mm Toma DIGITAL OUT: minitoma mono de 3,5 mm
Terminal de entrada	DC IN 3 V a 5 V (suministro de alimentación exterior)
Nivel de salida	15 mW + 15 mW (16 Ω , a 1 kHz)
Salida de línea	0,8 V (47 k Ω a 1 kHz)
Consumo	0,9 W
Alimentación	3 V CC: Batería de acumuladores de plomo recargable suministrada o toma DC IN para suministro exterior 120 V CA, 60 Hz (EE.UU. y Canadá, utilizando el adaptador para batería de automóvil suministrado) 220-240 V CA, 50 Hz (Reino Unido, Europa y Australia, utilizando el adaptador de CA suministrado) 110-120/220-240 V CA, 50/60 Hz (todos los demás países, utilizando el adaptador de CA suministrado)
Duración de las pilas	1,5 horas aproximadamente (repetición de reproducción continua) (puede variar en función de la condición de carga)
Dimensiones (L x Al x An)	130 x 34 x 137 mm
Peso	490 grms (sin pilas recargable)
Accesorios	1 cable de conexión 1 adaptador de CA 1 Adaptador de recarga 1 control remoto (RC-P81) 1 adaptador para equipo de audio de automóvil (CAC-1) 2 Pilas (AAA) 4 Pilas recargable (AA)

KENWOOD sigue una política de continuos avances en el desarrollo de modelos. Por esta razón las especificaciones están sujetas a cambios sin previo aviso.



KENWOOD

KTFP02K*XX